

vistosi

2023-1
Price List / Euro

 **Vistosi**

Collezioni / Collections

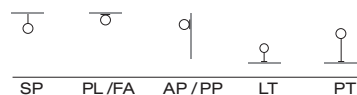
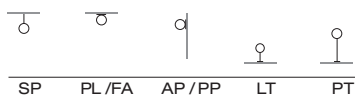

	SP	PL/FA	AP/PP	LT	PT	
24Pearls	●					20
Alega				●		20
Aria	●					20
Armonia	●		●			21
Assiba	●			●		21
Aurora		●	●			21
Baco	●		●			22
Balance	●	●	●			22
Bianca		●	●			23
Bissa				●		23
Bissona				●		23
Bolle	●	●		●		24
Bot	●	●	●			24
Candela	●					25
Cleo	●		●			25
Cloth	●		●	●	●	26
Corner			●			26
Cristallina	●					26
Dafne			●			27
Damasco	●	●	●	●	●	27
Diadema	●	●	●	●	●	28
Diamante	●	●	●			30
Dress	●					30
Ecos	●	●	●		●	31
Essence	●					31
Ferea				●		31
Futura	●	●	●	●	●	32
Giogali	●	●	●		●	33
Giogali3d	●					37
Gloria					●	37
Goccia			●			37
Goto				●		38
Implode	●	●	●	●		38
Incanto	●	●				39
Infinita	●	●	●			39
Jo				●		40
Jube	●		●	●	●	40
Kira	●					41
Lacrima	●					41
Lepanto	●				●	41
Lio	●	●	●	●		42
Lucciola	●	●	●	●	●	43
Medea	●					44
Mia		●	●			44

	SP	PL/FA	AP/PP	LT	PT	
Minigiogali	●	●	●	●	●	35
Mirage	●					45
Moris		●	●			45
Munega				●		45
Naranja	●					46
Naxos	●			●	●	46
Neochic	●	●	●			47
Nessa				●		48
Ninfea	●					48
Nodo	●					48
Novecento	●	●		●	●	49
Oro	●					49
Oto	●					50
Ovalina			●			51
Peggy	●		●		●	51
Phoenix	●					52
Plot	●					52
Plot Frame	●		●		●	52
Poc	●	●	●	●		53
Pod		●	●			53
Puppet	●		●	●		53
Puppet Ring	●		●			55
Riflesso	●			●		55
Riga		●	●			56
Rina	●	●	●	●	●	56
Saba		●	●			57
Sata				●	●	58
Scintilla	●					58
Semai	●	●	●			58
Sissi	●					59
Smoking					●	59
Soft		●	●			60
Sogno		●	●			60
Spirit	●	●	●	●		60
Stardust	●		●			61
Starnet	●					62
Stone	●					62
Surface	●					62
Tread	●		●	●		63
Trepai					●	63
Tubes	●	●				64
Vega				●	●	65
Whitwhite	●		●			65

Collezioni / Collections	2
Indice / Index	3
Legenda materiali / Materials keys	4
Colori del vetro / Glass colours	4
Finiture del vetro / Glass finishes	4
Finiture delle parti metalliche / Metal parts finishes	5
Altre finiture / Other finishes	5
Simboli / Symbols description	6
Opzioni dimmer / Dimmer options	8
Come leggere il listino / How to read the price list	9
Decentramenti / Swag systems	10
Caratteristiche LED / LED features	11
Listino prezzi 2023 / Price list 2023	19
Condizioni di vendita / Sales conditions	67
MyVistosi_Web_Social media	71

Legenda materiali / Materials keys

	colori vetro	glass colours	Glasfarben	couleurs verre	coloures vidrio
AA	ametista chiara	light amethyst	Amethyst hell	améthyste claire	amatista clara
AD	ambra scura	dark amber	Bernstein dunkel	ambre foncé	ambar oscuro
AM	ambra	amber	Bernstein	ambre	ámbar
AT	ametista	amethyst	Amethyst	améthyste	amatista
BC	bianco	white	weiß	blanc	blanco
CR	cristallo	crystal	kristall	cristal	cristal
FU	fumè	smoky	rauchglas	fumée	ahumado
GR	grigio	grey	grau	gris	gris
NE	nero	black	schwarz	noir	negro
SB	sabbia	sand	sandfarben	sable	arena
SE	seta	silk	seide	soie	seda
TB	terra bruciata	burned earth	erdbraun	terre brûlée	tierra quemada
VA	verde antico	old green	grün	vert ancien	verde antiguo

	finiture vetro	glass finishes	Glasausführungen	finitions verre	acabados vidrio
.. / AG	.. / argento	.. / silver	.. / Silber	.. / argent	.. / plata
.. / BC	.. / bianco	.. / white	.. / weiß	.. / blanc	.. / blanco
.. / BO	.. / "bolle"	.. / "bubbles"	.. / mit Blasen	.. / "bulles"	.. / "burbujas"
.. / BR	.. / bronzo	.. / bronze	.. / Bronze	.. / bronze	.. / bronce
.. / BT	.. / "balloton"	.. / "balloton"	.. / „balloton“	.. / "balloton"	.. / "balloton"
.. / CM	.. / metallizzato	.. / metallized	.. / metallic	.. / métallisé	.. / metalizado
.. / DI	.. / diffusore lucido	.. / glossy diffuser	.. / Difusor glänzend	.. / diffuseur brillant	.. / difusor brillante
.. / FO	.. / foglia oro	.. / gold leaf	.. / Blattgold	.. / feuille d'or	.. / hoja oro
.. / LU	.. / lucido	.. / glossy	.. / glänzend	.. / brillant	.. / brillante
.. / MF	.. / metallizzato sfumato	.. / shaded metallized	.. / metallic getönt	.. / métallisé fumé	.. / metalizado sombreado
.. / MU	.. / "murrina"	.. / "murrina"	.. / „murrina“	.. / "murrina"	.. / "murrina"
.. / NE	.. / nero	.. / black	.. / schwarz	.. / noir	.. / negro
.. / NN	.. / nickel nero	.. / black nickel	.. / Nickel schwarz	.. / nickel noir	.. / níquel negro
.. / OR	.. / oro	.. / gold	.. / Gold	.. / or	.. / oro
.. / PU	.. / "pulegoso"	.. / "pulegoso"	.. / „pulegoso“	.. / "pulegoso"	.. / "pulegoso"
.. / RA	.. / rame	.. / copper	.. / Kupfer	.. / cuivre	.. / cobre
.. / RI	.. / rigadin	.. / striped glass	.. / gestreift	.. / rigadin	.. / a rayas
.. / RV	.. / rigadin verticale	.. / striped vertical glass	.. / senkrecht gestreift	.. / lignes verticales	.. / a rayas vertical
.. / SF	.. / sfumato	.. / shaded	.. / abgetönt	.. / dégradé	.. / sombreado
.. / ST	.. / satinato	.. / matt	.. / satiniert	.. / satiné	.. / satinado
.. / TR	.. / trasparente	.. / transparent	.. / transparent	.. / transparent	.. / transparente



.. / **BO**



.. / **BT**



.. / **PU**

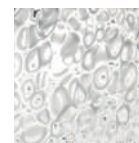

.. / **MU**

Legenda materiali / Materials keys

	finiture parti metalliche	metal parts finishes	Ausführung Metallteile	finitions parties métalliques	acabados partes metálicas
AB	alluminio bronzo	bronze aluminium	Aluminium Bronze	aluminium bronze	aluminio bronce
AS	acciaio specchiato	mirrored steel	Stahl satiniert verspiegelt	acier réfléchissant	acero espejado
AVS	acciaio satinato	matt steel	Stahl satiniert	acier satiné	acero satinado
BC	bianco lucido	glossy white	weiß glänzend	blanc brillant	blanco brillante
BD	bianco opaco 2	matt white 2	weiß matt 2	blanc mat 2	blanco mate 2
BH	bronzo lucido 2	glossy bronze 2	Bronze glänzend 2	bronze brillant 2	bronce brillante 2
BHS	bronzo satinato 3	matt bronze 3	Bronze satiniert 3	bronze satiné 3	bronce satinado 3
BKL	ottone lucido	glossy brass 1	Messing glänzend	laiton brillant	latón brillante
BKS	oro satinato 3	matt gold 3	Gold satiniert 3	or dépoli 3	oro satinado 3
BO	bianco opaco 1	matt white 1	weiß matt 1	blanc mat 1	blanco mate 1
BR	bronzo opaco 1	matt bronze 1	Bronze matt 1	bronze mat 1	bronce mate 1
BS	bronzo satinato 2	matt bronze 2	Bronze satiniert 2	bronze satiné 2	bronce satinado 2
BV	bronzo lucido 1	glossy bronze 1	Bronze glänzend 1	bronze brillant 1	bronce brillante 1
CR	cromo lucido	glossy chrome	Chrom glänzend	chrome brillant	cromo brillante
GR	grigio	grey	grau	gris	gris
MA	marrone	brown	braun	marron	marrón
NE	nero opaco 1	matt black 1	schwarz matt 1	noir mat 1	negro mate 1
NEL	nero lucido	glossy black	schwarz glänzend	noir brillant	negro brillante
NEO	nero opaco 2	matt black 2	schwarz matt 2	noir mat 2	negro mate 2
NI	nickel satinato	satin nickel	Nickel satiniert	nickel satiné	níquel satinado
NIB	nickel - bianco	nickel - white	Nickel - weiß	nickel - blanc	níquel - blanco
NL	nickel lucido	glossy nickel	Nickel glänzend	nickel brillant	níquel brillante
NN	nickel nero	black nickel	Nickel schwarz	nickel noir	níquel negro
NNS	nickel nero satinato	matt black nickel	Nickel schwarz satiniert	nickel noir satiné	níquel negro satinado
NO	nickel opaco	matt nickel	Nickel matt	nickel mat	níquel mate
N_O*	nero - oro satinato 3	black - matt gold 3	schwarz - Gold satiniert 3	noir - or dépoli 3	negro - oro satinado 3
N_R*	nero - rame	black - copper	schwarz - Kupfer	noir - cuivre	negro - cobre
OA	oro rosa satinato	matt pink gold	Gold rosa satiniert	or rose dépoli	oro rosa satinado
OG	ottone lucido 2	glossy brass 2	Messing glänzend 2	laiton brillant 2	latón brillante 2
OP	oro satinato 1	matt gold 1	Gold satiniert 1	or dépoli 1	oro satinado 1
OR	oro lucido	glossy gold	Gold glänzend	or brillant	oro brillante
OS	oro satinato 2	matt gold 2	Gold satiniert 2	or dépoli 2	oro satinado 2
OT	ottone anticato	antique brass	Messing antik	laiton vieilli	latón aspecto antiguo
OTL	ottone	brass	Messing	laiton	latón
OTS	ottone satinato	matt brass	Messing satiniert	laiton satiné	latón satinado
RA	rame lucido	glossy copper	Kupfer glänzend	cuivre brillant	cobre brillante
RAS	rame satinato 1	matt copper 1	Kupfer satiniert 1	cuivre satiné 1	cobre satinado 1
RAV	rame satinato 2	matt copper 2	Kupfer satiniert 2	cuivre satiné 2	cobre satinado 2
R_N	rame lucido - nero opaco	glossy copper - matt black	Kupfer glänzend - schwarz matt	cuivre brillant - noir mat	cobre brillante - negro mate

N_O*

N = NNS (external finish)
O = BKS (internal finish)

N_R*

N = NNS (external finish)
R = RAV (internal finish)

	altre finiture	other materials	Sonstige Ausführungen	autres finitions	otros acabados
LFN	legno frassino nero	black ash wood	Holz Esche schwarz	bois frêne noir	madera fresno negro
LFR	legno frassino naturale	natural ash wood	Holz Esche natur	bois frêne naturel	madera fresno natural
LNO	legno noce naturale	natural walnut wood	Holz Nussbaum natur	bois noyer naturel	madera nogal natural

Simboli / Symbols description



- CLASSE 1: isolamento funzionale in ogni parte, provvisto di messa a terra o con morsetto, se fisso, o con conduttore e relativa spina con contatto di terra, se mobile.
- CLASS 1: functional insulation in every part and ground terminal or clamp if the unit is fixed, or with conductor and relative plug with ground contact if the unit is mobile.
- KLASSE 1: Isolierung jedes Bestandteiles mit Erdung, bzw. mit Klemme falls festmontiert oder Drahtleitung und Schuko-Stecker falls beweglich.
- CLASSE 1: isolement fonctionnel de toutes les composantes, avec mise à la terre ou borne si l'appareil est fixe avec conducteur et fiche avec contact à la terre si l'appareil est mobile.
- CLASE 1: aislamiento funcional en cada componente, provisto de descarga a tierra o con borne si fijo o con conductor y adecuada enchufe con contacto a tierra si móvil.



- CLASSE 2: doppio isolamento e/o isolamento rinforzato in ogni parte e senza dispositivi di messa a terra.
- CLASS 2: double insulation and/or reinforced insulation in every part and without ground devices.
- KLASSE 2: doppelte Isolierung, bzw. verstärkte Isolierung jedes Teiles, ohne Vorrichtung für Erdung.
- CLASSE 2: double isolement et/ou isolement renforcé de toutes les composantes et sans dispositif de mise à la terre.
- CLASE 2: doble aislamiento y/o aislamiento reforzado en cada componente y sin dispositivo de contacto a tierra.



- CLASSE 3: apparecchio in cui la protezione contro la scossa elettrica si basa sull'alimentazione a bassissima tensione di sicurezza (SELV) e in cui non si producono tensioni superiori alla stessa.
- CLASS 3: luminaire in which protection against electric shock relies on supply at safety extra-low voltage (SELV) and in which voltages higher than those of SELV are not generated.
- KLASSE 3: Gerät dessen Schutz gegen Stromschlag auf einer Stromversorgung mit Sicherheitskleinspannung (SELV) basiert und das selbst keine höhere Spannung erzeugen kann.
- CLASSE 3: dispositif dans lequel la protection contre les chocs électriques est basée sur l'alimentation à très basse tension de sécurité (SELV) et dans lequel aucune tension supérieure à celle-ci n'est produite.
- CLASE 3: aparato en el que la protección contra descargas eléctricas se basa en la fuente de alimentación de muy baja tensión de seguridad (SELV) y en el que no se producen tensiones superiores a la misma.

IPXX

- Grado di protezione dell'apparecchio ai solidi-liquidi.
- Level of protection of electronic equipments against solids and liquids.
- Der Schutzgrad aller Leuchten gegen äussere Einwirkungen.
- Indice de Protection.
- El grado de protección del aparato a sólidos-liquidos.



- Il simbolo appare sull'etichetta posta sul prodotto quando lo stesso NON è predisposto per il montaggio diretto su superfici normalmente infiammabili montato a parete o a soffitto (idoneo solo al montaggio su superfici non combustibili).
- The symbol appears on the label attached to the product if it is NOT intended for direct mounting on normally combustible surfaces on the wall or on the ceiling (only suitable for mounting on non-flammable surfaces).
- Das Symbol erscheint auf dem Etikett, das am Produkt angebracht ist, wenn dieses NICHT für die direkte Montage auf normal brennbaren Oberflächen an der Wand oder auf der Decke, vorgesehen ist (nur zur Montage auf nicht brennbaren Oberflächen geeignet).
- Le symbole apparaît sur l'étiquette apposée sur le produit lorsqu'il n'est PAS conçu pour un montage direct sur des surfaces normalement inflammables montées au mur ou au plafond (convient uniquement pour le montage sur des surfaces non combustibles).
- El símbolo aparece en la etiqueta colocada en el producto cuando NO está diseñado para montaje directo en superficies normalmente inflamables montadas en la pared o el techo (solo apto para montaje en superficies no combustibles).



- Il simbolo appare sull'etichetta posta sul prodotto quando lo stesso NON è predisposto per il montaggio diretto su superfici normalmente infiammabili ad incasso (idoneo solo al montaggio su superfici non combustibili).
- The symbol appears on the label attached to the product if it is NOT intended for direct mounting as a built-in element on normally flammable surfaces (only suitable for mounting on non-flammable surfaces).
- Das Symbol erscheint auf dem am Produkt angebrachten Etikett, wenn es NICHT für die direkte Montage als Einbauelement auf normal entflammaren Oberflächen vorgesehen ist (nur zur Montage auf nicht brennbaren Oberflächen geeignet).
- Le symbole apparaît sur l'étiquette apposée sur le produit lorsqu'il n'est PAS conçu pour un montage direct sur des surfaces encastrées normalement inflammables (convient uniquement pour le montage sur des surfaces non combustibles).
- El símbolo aparece en la etiqueta colocada en el producto cuando NO está diseñado para montaje directo empotrado en superficies normalmente inflamables (solo apto para montaje en superficies no combustibles).

F

- Fino ad esaurimento scorte.
- Until stock availability.
- Solange der Vorrat reicht.
- Jusqu'à épuisement des stocks.
- Disponibile hasta fin de existencias.

m³

- Volume totale dei colli che compongono l'articolo.
- Total volume of the packages that make up the article.
- Gesamtvolumen der Pakete, aus denen der Artikel besteht.
- Volume total de colis qui composent l'article.
- Volumen total de los bultos que componen el artículo.



- Peso netto indicativo del prodotto (con tolleranza +/- 20%).
- Approximate net weight of the product (with a tolerance of +/- 20%).
- Ungefähres Nettogewicht des Produkts (mit einer Toleranz von +/- 20%).
- Poids net approximatif du produit (avec tolérance +/- 20%).
- Peso neto aproximado del producto (con tolerancia +/- 20%).

Simboli / Symbols description



- Certificato di "Conformità Europea", indica che il prodotto è conforme alle norme di sicurezza Europee.
- "European Conformity" marking, which indicates that the product complies with the European safety standards.
- Das Zertifikat von "Europäischer Konformität" zeigt an, dass das Produkt den europäischen Sicherheitsnormen entspricht.
- Ce certificat de "Conformité Européenne" indique que le produit est conforme aux normes européennes de sécurité.
- Certificado de "Conformidad Europea", que indica que el producto cumple con las normas de seguridad europeas.



- È il massimo delle certificazioni di prodotto vigenti in Europa. Per ottenere questo certificato, il prodotto deve superare i test di sicurezza Europei, ma anche i test specifici richiesti da tutti gli stati membri.
- It is the high quality European certification for products. In order to obtain it, the product must pass the European security tests as well as the specific tests required by each Member State.
- Es ist die wichtigste geltende Produktzertifizierung in Europa. Damit dieses Zertifikat ihm zugestanden wird, muss das Produkt europäische Sicherheitstests, und auch die spezifischen Tests bestehen, die alle Mitgliedstaaten erfordern.
- C'est la plus importante certification de produits en vigueur en Europe. Pour qu'on lui accorde ce certificat, le produit doit passer des tests de sécurité européens, mais aussi les tests spécifiques requis par tous les États membres.
- Es la más alta certificación de producto vigente en Europa. Para obtener este certificado el producto debe superar tanto las pruebas de seguridad europeas como aquellas específicas requeridas por todos los miembros de la CE.



- Certificato di conformità del prodotto alle normative di sicurezza elettro-technica della Federazione Russa.
- Certification indicating products that conform to the electro-technical safety regulations of the Russian Federation.
- Dieses Zeichen steht für „Staatlichen Standard“ und stellt die Bescheinigung der Konformität eines Produkts mit den technischen Standards der Russischen Föderation dar.
- Cet acronyme signifie « Standard d'État » et indique l'attestation de conformité d'un produit aux normes techniques de la Fédération de Russie.
- Indica que el producto cumple con las normas técnicas nacionales de la Federación Rusa.



- Certificato di conformità del prodotto alle normative di sicurezza elettro-technica della Cina.
- Certification indicating products that conform to the electro-technical safety regulations of China.
- Konformitätszertifikat des Produkts mit den elektrisch-technischen Sicherheitsnormen von China.
- Certificat de conformité du produit aux normes de sécurité électrotechnique de la Chine.
- Certificado de conformidad del producto con las normas de seguridad electrotécnica de China.



- Certificato internazionale di sicurezza elettro-technica di prodotto, riconosciuto da oltre 50 Paesi.
- International Certification of electro-technical product safety, recognized by over 50 countries.
- Internationales Zertifikat für elektrisch-technische Produktsicherheit, anerkannt in über 50 Ländern.
- Certificat international de sécurité des produits électrotechniques, reconnu par plus de 50 pays.
- Certificado internacional de seguridad electrotécnica de producto, reconocido por más de 50 países.



- Certificato di conformità del prodotto alle normative di sicurezza elettro-technica del Giappone. Disponibile solo su richiesta e fornito da Doi&Co. Luminabella Div.
- Certification indicating products that conform to Japan's electro-technical safety regulations. Available only on request and supplied by Doi & Co. Luminabella Div.
- Zertifikat der Konformität des Produkts mit den elektrisch-technischen Sicherheitsnormen von Japan. Erhältlich nur auf Anfrage, geliefert von Doi&Co. Luminabella Div.
- Certificat de conformité du produit aux normes de sécurité électrotechnique du Japon. Disponible uniquement sur demande et fourni par Doi&Co. Luminabella Div.
- Certificado de conformidad del producto con las normas de seguridad electrotécnica de Japón. Disponible solo bajo demanda y suministrado por Doi&Co. Luminabella Div.



- Certificato di conformità del prodotto alle normative di sicurezza elettro-technica degli Stati Uniti e del Canada. Disponibile per i mercati di riferimento.
- Certification of product conformity to the electro-technical safety regulations of the United States and Canada. Available for the specific markets.
- Zertifikat der Konformität des Produkts mit den elektrisch-technischen Sicherheitsnormen der USA und Kanada. Erhältlich für die entsprechenden Länder.
- Certificat de conformité du produit aux normes de sécurité électrotechnique des États-Unis et du Canada. Disponible pour les marchés de référence.
- Certificado de conformidad del producto con las normas de seguridad electrotécnica de los Estados Unidos y de Canadá. Disponible para los mercados de referencia.



- Simbolo che indica che l'apparecchio è conforme alle linee guida dell'Americans with Disabilities Act (ADA).
- Symbol indicating that the device complies with the guidelines of the Americans with Disabilities Act (ADA).
- Symbol das angibt, dass das Gerät den Richtlinien des „Americans with Disabilities Act“ (ADA) entspricht.
- Symbole indiquant que l'appareil est conforme aux directives de l'Americans with Disabilities Act (ADA).
- Simbolo que indica que el aparato es conforme con las pautas del "Americans with Disabilities Act" (ADA).

Opzioni dimmer / Dimmer options

- DIM1**
- Lampada predisposta per essere dimmerata con un sistema a "taglio di fase". Attenzione, in caso di utilizzo di lampadine retrofit a LED assicurarsi che queste siano di tipo dimmerabile.
 - Lamp designed to be dimmed with a "phase cut" system. Attention: when using retrofit LED bulbs, make sure that they are dimmable.
 - Diese Leuchte kann mit einem Phasen-Abschnitt System gedimmt werden. Beachten Sie bitte, dass im Falle LED retrofit-Leuchtmittel verwendet werden, diese auch dimmbar sind.
 - Luminaire prévu pour être réglé avec le système dit de « découpage de phase ». Attention, en cas d'utilisation d'une source LED adaptable, assurez-vous qu'elle soit prévue pour la variation de lumière.
 - Lámpara preparada para regulación de luz mediante sistema "corte de fase". Cuidado, cuando se utilicen bombillas LED retrofit, asegúrense que estas sean dimmables en los niveles de luz.
-

- DIM2**
- Lampada predisposta per essere dimmerata con un sistema a "taglio di fase". Attenzione, assicurarsi che il sistema supporti i bassi wattaggi del LED.
 - Lamp designed to be dimmed with a "phase cut" system. Attention: make sure that the system supports LED low wattages.
 - Diese Leuchte kann mit einem Phasen-Abschnitt System gedimmt werden. Beachten Sie bitte, dass das LED Leuchtmittel für eine niedrige Wattleistung vorgesehen ist.
 - Luminaire prévu pour être réglé avec le système dit de « découpage de phase ». Attention, assurez-vous que le système supporte la puissance basse de la LED.
 - Lámpara preparada para regulación de luz mediante sistema "corte de fase". Cuidado, asegúrense que el sistema soporte la baja potencia del LED.
-

- DIM3**
- Lampada predisposta per essere dimmerata con un sistema a 0-10V / 1-10V / PUSH.
 - Lamp designed to be dimmed with a system with 0-10V / 1-10V / PUSH.
 - Diese Leuchte kann mit einem 0-10V / 1-10V / PUSH System gedimmt werden.
 - Luminaire prévu pour une variation de lumière par le système 0-10V / 1-10V / PUSH.
 - Lámpara preparada para regulación de luz mediante sistema 0-10V / 1-10V / PUSH.
-

- DIM4**
- Lampada con dimmer incluso.
 - Lamp including dimmer.
 - Lampe inklusive Dimmer.
 - Lampe avec variateur inclus.
 - Lámpara con dimmer incluido.
-

- DIM5**
- Lampada predisposta per essere dimmerata con un sistema DALI. Disponibile su richiesta e solo su prodotti che tecnicamente ne consentono l'installazione.
 - Lamp designed to be dimmed with a DALI system. Available on request and only for products that technically allow its installation.
 - Diese Leuchte kann mit einem DALI System gedimmt werden, welches nur auf Anfrage geliefert und nur auf dafür geeigneten Produkten eingebaut werden kann.
 - Luminaire prévu pour être réglé avec un système DALI. Disponible sur commande et seulement sur produits compatibles avec l'installation de ce système.
 - Lámpara preparada para regulación de luz mediante sistema DALI. Disponible a petición y solo para productos cuya instalación esté técnicamente prevista.
-

- DIM6**
- Lampada predisposta per essere dimmerata con un sistema DMX. Disponibile su richiesta e solo su prodotti che tecnicamente ne consentono l'installazione.
 - Lamp designed to be dimmed with a DMX system. Available on request and only for products that technically allow its installation.
 - Diese Leuchte kann mit einem DMX System gedimmt werden, welches nur auf Anfrage geliefert und nur auf dafür geeigneten Produkten eingebaut werden kann.
 - Luminaire prévu pour être réglé avec un système DMX. Disponible sur commande et seulement sur produits compatibles avec l'installation de ce système.
 - Lámpara preparada para regulación de luz mediante sistema DMX. Disponible a petición y solo para productos cuya instalación esté técnicamente prevista.
-

- ON/OFF**
- Non dimmerabile.
 - Not-dimmable.
 - Nicht dimmbar.
 - Sans variation.
 - No dimmerable.
-

- ON/OFF***
- Lampada predisposta per l'installazione di un dimmer optional compatibile con lampadine dimmerabili alogene, a incandescenza e retrofit LED dimmerabili.
 - Lamp for the installation of an optional dimmer, which is compatible with halogen, incandescent and dimmable LED retrofit lamps.
 - Lampe für die Installation eines optionalen Dimmers, der mit Halogen-, Glüh- und dimmbaren LED-Nachrüstlampen kompatibel ist.
 - Lampe conçue pour l'installation d'un variateur optionnel compatible avec les ampoules de retrofit LED halogènes, incandescentes et dimmables.
 - Lámpara diseñada para la instalación de un atenuador opcional compatible con bombillas de retroadaptación halógenas, incandescentes y LED atenuables.

Come leggere il listino / How to read the price list

Tipologia / Type

AP	parete	wall	Wandleuchte	applique	de pared
FA	faretto	spotlight	Einbauleuchte	spot	foco de suspension
LT	tavolo	table	Tischleuchte	table	de mesa
PL	plafoniera	ceiling	Deckenleuchte	plafonnier	de techo
PP	parete - soffitto	wall - ceiling	Wandleuchte - Decken	applique - plafonnier	de pared - de techo
PT	terra	floor	Stehleuchte	terre	de pie
SP	sospensione	suspension	Pendelleuchte	suspension	suspension

Legenda codici prodotto / Product codes keys

es. ex.	codice prodotto product code	tipologia type	modello model	colore vetro glass colour	finitura vetro glass finish	finitura struttura metal part finish	sorgente lamping
1	ASSIBA SP G BC/BT CR E27	sospensione suspension	grande large	bianco white	/ balloton balloton	cromo chrome	E27
2	ASSIBA SP 2 CR/BT CR LED	sospensione suspension	2 vetri 2 glasses	cristallo crystal	/ balloton balloton	cromo chrome	LED

dimensioni / dimensions

decentramenti / swag systems

SURFACE

design Giovanni Barbato 2017

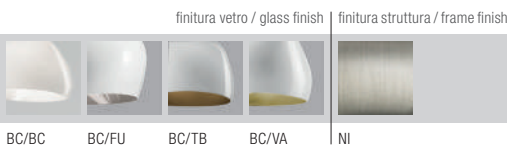
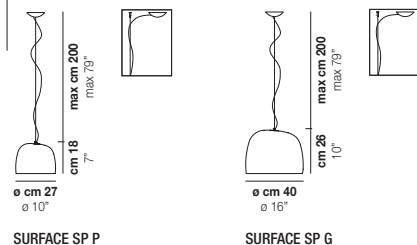

lumen @3000K

opzioni temperatura colore / colour temperature options

codice / code	vetro / glass	struttura / frame	W	lumen @3000K	°K option	dimmer option	kg	m³	EU cert.	International cert.	€
F SURFACE SPP	BC/BC BC/FU BC/TB BC/VA	NI	E27	1x77W		DIM1	2,5	0,05	IP20	CE CB EAC	300,00
SURFACE SP G	BC/BC BC/FU BC/TB BC/VA	NI	E27	1x77W		DIM1	5,0	0,10	IP20	CE CB EAC	370,00
SURFACE SP G	BC/BC BC/FU BC/TB BC/VA	NI	LED C	12W	1600	2700 3000 DIM2 DIM3	5,0	0,10	IP20	CE CB EAC	535,00

codice prodotto / product code

finitura vetro / glass finish

finitura montatura / metal part finish

sorgente luminosa / lighting source

versione LED Europa / European LED versions

lampadine / bulbs

opzioni dimmer / dimmer options

peso netto / net weight

volume / volume

classe / class

grado di protezione / level of protection
ai solidi-liquidi against solids-liquids

certificazioni Europa / Europe certifications

certificazioni Internazionali / International certifications

prezzo / price
IVA esclusa / VAT excluded

fino ad esaurimento scorte / until stock availability

Decentramenti / Swag systems

Versioni precedenti / Previous versions

Nuova versione / New version

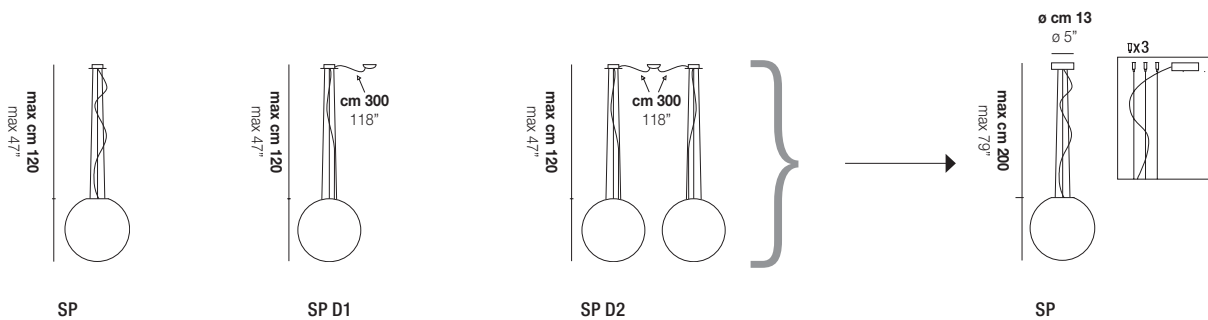
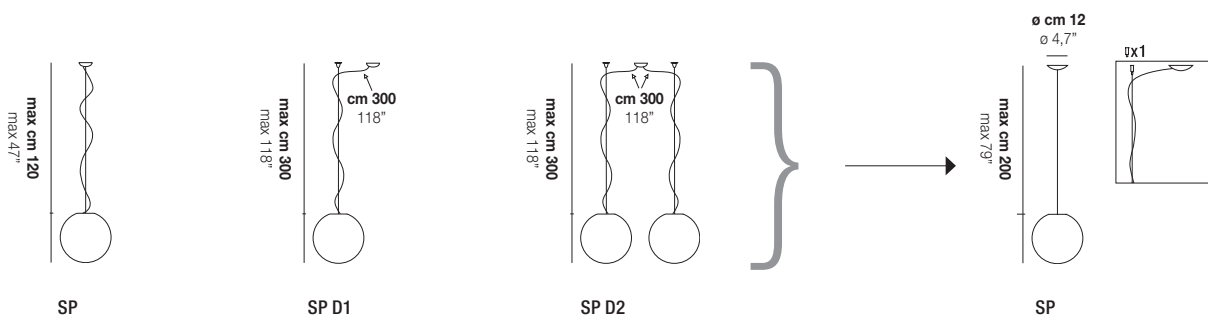
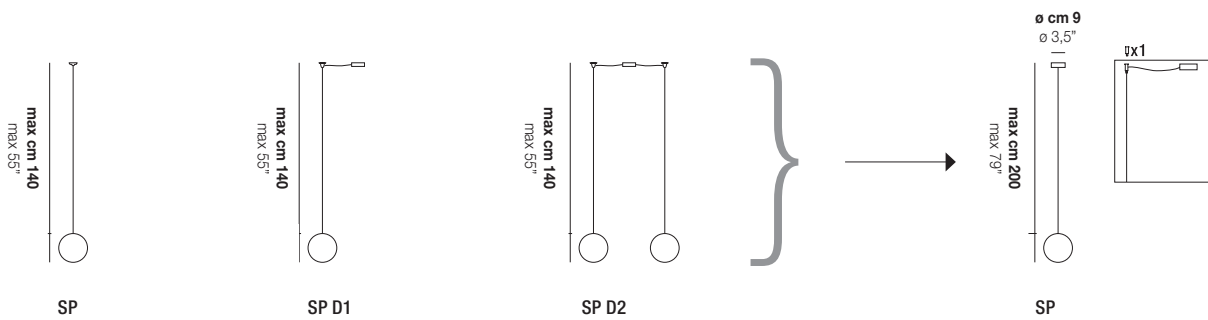

Decentramento a 2 luci per lampade con driver LED / Two lights swag system for lamps with LED driver

OLD
Doppio collegamento elettrico / dimmerazione
Double power / dimming supply

NEW
Singolo collegamento elettrico / dimmerazione
Single power / dimming supply



*Rosone da ordinare a parte
Canopy to be purchased separately

Caratteristiche LED / LED features

LED A



LED B

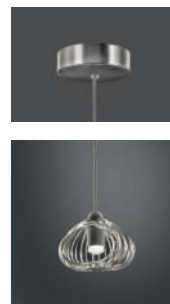

caratteristiche / features

		Europe	USA & Canada
vita media / average lifetime	ore / h	45.000	45.000
flusso luminoso / luminous flux	lm	1.100 / 1.200	1.100 / 1.200
temperatura colore / colour temperature	°K option*	2700 3000	2700 3000
CRI	Ra	≥90	≥90
efficienza / efficiency	lm/W	120 / 130	120 / 130
tensione media / average tension	V	34	34
consumo / power consumption	W	9W @260mA	9W @260mA
dimmerazione / dimming	DIM2 DIM3*	Phase Cut / 0-10V, Push	Phase Cut / 0-10V, Push

		Europe	USA & Canada
ore / h		45.000	45.000
lm		1.100 / 1.200	1.100 / 1.200
°K option*		2700 3000	2700 3000
Ra		≥90	≥90
lm/W		120 / 130	120 / 130
V		34	34
W		9W @260mA	9W @260mA
DIM2 DIM3*		Phase Cut / 0-10V, Push	Phase Cut / 0-10V, Push

* Altre opzioni disponibili su richiesta / Other options available on request

LED C



LED D



caratteristiche / features

		Europe	USA & Canada
vita media / average lifetime	ore / h	40.000	40.000
flusso luminoso / luminous flux	lm	1.500 / 1.600	1.500 / 1.600
temperatura colore / colour temperature	°K option*	2700 3000	2700 3000
CRI	Ra	≥90	≥90
efficienza / efficiency	lm/W	110 / 120	110 / 120
tensione media / average tension	V	35	35
consumo / power consumption	W	12W @340mA	12W @340mA
dimmerazione / dimming	DIM2 DIM3*	Phase Cut / 0-10V, Push	Phase Cut / 0-10V, Push

		Europe	USA & Canada
ore / h		45.000	45.000
lm		1.100 / 1.200	1.100 / 1.200
°K option*		2700 3000	2700 3000
Ra		≥90	≥90
lm/W		120 / 130	120 / 130
V		34	34
W		9W @260mA	9W @260mA
DIM2 DIM3*		Phase Cut / 0-10V, Push	Phase Cut / 0-10V, Push

* Altre opzioni disponibili su richiesta / Other options available on request

Caratteristiche LED / LED features

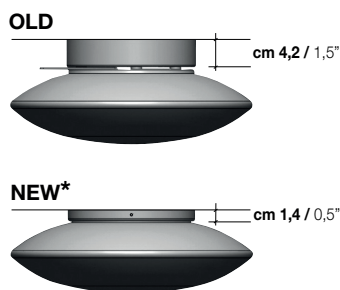

Altezza ridotta da 4,2 cm (1,5") a 1,4 cm (0,5")
Reduced height from 4,2 cm (1,5") to 1,4 cm (0,5")

LED F*



LED G*



caratteristiche / features

Europe

USA & Canada

		Europe	USA & Canada
vita media / average lifetime	ore / h	50.000	50.000
flusso luminoso / luminous flux	lm	1.700	1.700
temperatura colore / colour temperature	°K option*	2700 3000	2700 3000
CRI	Ra	≥90	≥90
efficienza / efficiency	lm/W	140	140
tensione media / average tension	V	24	24
consumo / power consumption	W	12W @500mA	12W @500mA
dimmerazione / dimming	DIM2 DIM3*	Phase Cut / 0-10V, Push	Phase Cut / 0-10V, Push

Europe

USA & Canada

		Europe	USA & Canada
vita media / average lifetime	ore / h	50.000	50.000
flusso luminoso / luminous flux	lm	2.850	2.850
temperatura colore / colour temperature	°K option*	2700 3000	2700 3000
CRI	Ra	≥90	≥90
efficienza / efficiency	lm/W	150	150
tensione media / average tension	V	39	39
consumo / power consumption	W	19W @500mA	19W @500mA
dimmerazione / dimming	DIM2 DIM3*	Phase Cut / 0-10V, Push	Phase Cut / 0-10V, Push

* Altre opzioni disponibili su richiesta / Other options available on request

LED O*



LED 01



caratteristiche / features

Europe

USA & Canada

		Europe	USA & Canada
vita media / average lifetime	ore / h	50.000	50.000
flusso luminoso / luminous flux	lm	3.700	3.700
temperatura colore / colour temperature	°K option*	2700 3000	2700 3000
CRI	Ra	≥90	≥90
efficienza / efficiency	lm/W	150	150
tensione media / average tension	V	39	39
consumo / power consumption	W	26W @700mA	26W @700mA
dimmerazione / dimming	DIM2 DIM3*	Phase Cut / 0-10V, Push	Phase Cut / 0-10V, Push

Europe

USA & Canada

		Europe	USA & Canada
vita media / average lifetime	ore / h	40.000	40.000
flusso luminoso / luminous flux	lm	1.200	1.200
temperatura colore / colour temperature	°K option*	2700 3000	2700 3000
CRI	Ra	≥90	≥90
efficienza / efficiency	lm/W	150	150
tensione media / average tension	V	24	24
consumo / power consumption	W	8,5W @350mA	8,5W @350mA
dimmerazione / dimming	DIM2 DIM3*	Phase Cut / 0-10V, Push	Phase Cut / 0-10V, Push

* Altre opzioni disponibili su richiesta / Other options available on request

Caratteristiche LED / LED features

LED 02



LED 03



caratteristiche / features

vita media / average lifetime	ore / h	40.000
flusso luminoso / luminous flux	lm	2.000
temperatura colore / colour temperature	°K option*	2700 3000
CRI	Ra	≥90
efficienza / efficiency	lm/W	150
tensione media / average tension	V	37
consumo / power consumption	W	13W @350mA
dimmerazione / dimming		DIM2 DIM3*

Europe

USA & Canada

ore / h	40.000
lm	2.000
°K option*	2700 3000
Ra	≥90
lm/W	150
V	37
W	13W @350mA
	Phase Cut / 0-10V, Push

Europe

USA & Canada

ore / h	40.000
lm	1.500 / 1.600
°K option*	2700 3000
Ra	≥90
lm/W	110 / 120
V	35
W	12W @340mA
	Phase Cut / 0-10V, Push

* Altre opzioni disponibili su richiesta / Other options available on request

LED 04



LED 05



caratteristiche / features

vita media / average lifetime	ore / h	30.000
flusso luminoso / luminous flux	lm	2.000
temperatura colore / colour temperature	°K option*	2700 3000
CRI	Ra	≥90
efficienza / efficiency	lm/W	140
tensione media / average tension	V	28
consumo / power consumption	W	14W @500mA
dimmerazione / dimming		DIM2 DIM3*

Europe

USA & Canada

ore / h	30.000
lm	2.000
°K option*	2700 3000
Ra	≥90
lm/W	140
V	28
W	14W @500mA
	Phase Cut / 0-10V, Push

Europe

USA & Canada

ore / h	90.000
lm	1.400
°K option*	2700 3000
Ra	≥90
lm/W	130
V	35
W	10,5W @300mA
	Push

* Altre opzioni disponibili su richiesta / Other options available on request

Caratteristiche LED / LED features

LED 07



LED 08



caratteristiche / features

Europe

USA & Canada

		Europe	USA & Canada
vita media / average lifetime	ore / h	40.000	40.000
flusso luminoso / luminous flux	lm	2.850	2.850
temperatura colore / colour temperature	°K option*	2700 3000	2700 3000
CRI	Ra	≥90	≥90
efficienza / efficiency	lm/W	150	150
tensione media / average tension	V	39	39
consumo / power consumption	W	19,5W @500mA	19,5W @500mA
dimmerazione / dimming		DIM2 DIM3* Phase Cut / 0-10V, Push	Phase Cut / 0-10V, Push

Europe

USA & Canada

		Europe	USA & Canada
ore / h		50.000	50.000
flusso luminoso / luminous flux	lm	3.800	3.800
temperatura colore / colour temperature	°K option*	2700 3000	2700 3000
CRI	Ra	≥80	≥80
efficienza / efficiency	lm/W	115	115
tensione media / average tension	V	24	24
consumo / power consumption	W	35W	35W
dimmerazione / dimming		DIM2* Phase Cut / 0-10V, Push	NODIM

* Altre opzioni disponibili su richiesta / Other options available on request

LED 09

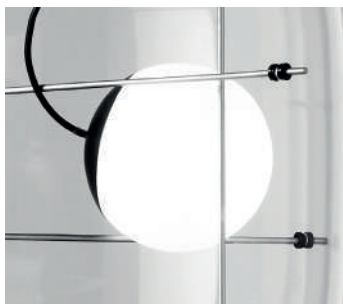

LED 10



caratteristiche / features

Europe

USA & Canada

		Europe	USA & Canada
vita media / average lifetime	ore / h	40.000	40.000
flusso luminoso / luminous flux	lm	1.700	1.700
temperatura colore / colour temperature	°K option*	2700 3000	2700 3000
CRI	Ra	≥90	≥90
efficienza / efficiency	lm/W	150	150
tensione media / average tension	V	~28	~28
consumo / power consumption	W	11W @400mA	11W @400mA
dimmerazione / dimming		DIM2 DIM3* Phase Cut / 0-10V, Push	Phase Cut / 0-10V, Push

Europe

USA & Canada

		Europe	USA & Canada
ore / h		90.000	90.000
flusso luminoso / luminous flux	lm	1.500	1.500
temperatura colore / colour temperature	°K option*	2700 3000	2700 3000
CRI	Ra	≥90	≥90
efficienza / efficiency	lm/W	130	130
tensione media / average tension	V	35	35
consumo / power consumption	W	12,5W @350mA	12,5W @350mA
dimmerazione / dimming		DIM2 DIM3* Phase Cut / 0-10V, Push	Phase Cut / 0-10V, Push

* Altre opzioni disponibili su richiesta / Other options available on request

Caratteristiche LED / LED features

LED 11



LED 12

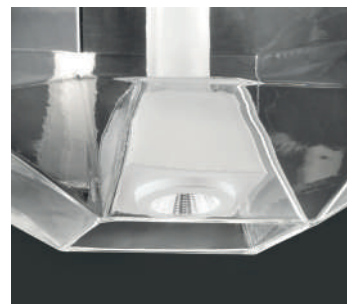

caratteristiche / features

vita media / average lifetime	ore / h	40.000
flusso luminoso / luminous flux	lm	1.500 / 1.600
temperatura colore / colour temperature	°K option*	2700 3000
CRI	Ra	≥90
efficienza / efficiency	lm/W	110 / 120
tensione media / average tension	V	35
consumo / power consumption	W	12W @340mA
dimmerazione / dimming	DIM2 DIM3 *	Phase Cut / 0-10V, Push

Europe

USA & Canada

vita media / average lifetime	ore / h	40.000
flusso luminoso / luminous flux	lm	1.500 / 1.600
temperatura colore / colour temperature	°K option*	2700 3000
CRI	Ra	≥90
efficienza / efficiency	lm/W	110 / 120
tensione media / average tension	V	35
consumo / power consumption	W	12W @340mA
dimmerazione / dimming	DIM2 DIM3 *	Phase Cut / 0-10V, Push

Europe

USA & Canada

vita media / average lifetime	ore / h	50.000
flusso luminoso / luminous flux	lm	1.000 / 1.200
temperatura colore / colour temperature	°K option*	2700 3000
CRI	Ra	≥90
efficienza / efficiency	lm/W	110
tensione media / average tension	V	29
consumo / power consumption	W	2W+8W @350mA
dimmerazione / dimming	DIM2 DIM3 *	Phase Cut / 0-10V, Push

* Altre opzioni disponibili su richiesta / Other options available on request

LED 13



LED 14



caratteristiche / features

vita media / average lifetime	ore / h	40.000
flusso luminoso / luminous flux	lm	1.500 / 1.600
temperatura colore / colour temperature	°K option*	2700 3000
CRI	Ra	≥90
efficienza / efficiency	lm/W	110 / 120
tensione media / average tension	V	35
consumo / power consumption	W	12W @340mA
dimmerazione / dimming	DIM2 DIM3 *	Phase Cut / 0-10V, Push

Europe

USA & Canada

vita media / average lifetime	ore / h	40.000
flusso luminoso / luminous flux	lm	1.500 / 1.600
temperatura colore / colour temperature	°K option*	2700 3000
CRI	Ra	≥90
efficienza / efficiency	lm/W	110 / 120
tensione media / average tension	V	35
consumo / power consumption	W	12W @340mA
dimmerazione / dimming	DIM2 DIM3 *	Phase Cut / 0-10V, Push

Europe

USA & Canada

vita media / average lifetime	ore / h	40.000
flusso luminoso / luminous flux	lm	1.200
temperatura colore / colour temperature	°K option*	2700 3000
CRI	Ra	≥90
efficienza / efficiency	lm/W	150
tensione media / average tension	V	24
consumo / power consumption	W	8,5W @350mA
dimmerazione / dimming	DIM2 DIM3 *	Phase Cut / 0-10V, Push

* Altre opzioni disponibili su richiesta / Other options available on request

Caratteristiche LED / LED features

LED 15



LED 16



caratteristiche / features

		Europe	USA & Canada
vita media / average lifetime	ore / h	40.000	40.000
flusso luminoso / luminous flux	lm	2.000	2.000
temperatura colore / colour temperature	°K option*	2700 3000	2700 3000
CRI	Ra	≥90	≥90
efficienza / efficiency	lm/W	150	150
tensione media / average tension	V	37	37
consumo / power consumption	W	13W @350mA	13W @350mA
dimmerazione / dimming	DIM4*	Push	Push

		Europe	USA & Canada
ore / h		40.000	40.000
lm		1.200	1.200
°K option*		2700 3000	2700 3000
Ra		≥90	≥90
lm/W		150	150
V		24	24
W		8,5W @350mA	8,5W @350mA
DIM4*		Push	Push

* Altre opzioni disponibili su richiesta / Other options available on request

LED 17



LED 18



caratteristiche / features

		Europe	USA & Canada
vita media / average lifetime	ore / h	50.000	50.000
flusso luminoso / luminous flux	lm	1.250	1.250
temperatura colore / colour temperature	°K option*	2700 3000	2700 3000
CRI	Ra	≥90	≥90
efficienza / efficiency	lm/W	150	150
tensione media / average tension	V	~28	~28
consumo / power consumption	W	8,5W @300mA	8,5W @300mA
dimmerazione / dimming	DIM2 DIM3*	Phase Cut / 0-10V, Push	Phase Cut / 0-10V, Push

		Europe	USA & Canada
ore / h		30.000	30.000
lm		1.900	1.900
°K option*		2700 3000	2700 3000
Ra		≥90	≥90
lm/W		150	150
V		24	24
W		12W @500mA	12W @500mA
DIM2 DIM3*		Phase Cut / 0-10V, Push	Phase Cut / 0-10V, Push

* Altre opzioni disponibili su richiesta / Other options available on request

Caratteristiche LED / LED features

LED 19



LED 20



caratteristiche / features

		Europe	USA & Canada
vita media / average lifetime	ore / h	30.000	30.000
flusso luminoso / luminous flux	lm	2.800	2.800
temperatura colore / colour temperature	°K option*	2700 3000	2700 3000
CRI	Ra	≥90	≥90
efficienza / efficiency	lm/W	150	150
tensione media / average tension	V	36,5	36,5
consumo / power consumption	W	18W @500mA	18W @500mA
dimmerazione / dimming	DIM2 DIM3*	Phase Cut / 0-10V, Push	Phase Cut / 0-10V, Push

		Europe	USA & Canada
ore / h		40.000	40.000
lm		600	600
°K option*		2700 3000	2700 3000
Ra		≥90	≥90
lm/W		120	120
V		10	10
W		5W @500mA	5W @500mA
DIM2 DIM3*		Phase Cut / 0-10V, Push	Phase Cut / 0-10V, Push

* Altre opzioni disponibili su richiesta / Other options available on request



2023-1

Price List / Euro

finitura vetro / glass finish

finitura struttura / frame finish

24PEARLS

design Romani Saccani Architetti Associati 2009



BC/CM

CR

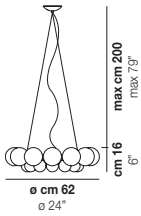

24PEARLS SP

codice / code	vetro / glass	struttura / frame	W	lumen @3000K	°K option	dimmer option	Ⓜ	m ³	EU cert.	International cert.	€
24PEARLSSP	BC/CM	CR	G9	12x33W		DIM1	8,5	0,20	IP20	CE EAC	2.562,00

finitura vetro / glass finish

finitura struttura / frame finish

ALEGA

design Vico Magistretti 1970



BC/CR

CR

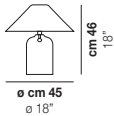

ALEGA LT

codice / code	vetro / glass	struttura / frame	W	lumen @3000K	°K option	dimmer option	Ⓜ	m ³	EU cert.	International cert.	€
ALEGALT	BC/CR	CR	E14	3x46W		ON/OFF*	4,5	0,16	IP20	CE EAC	773,00

* Vedi nota pagina 8 / See note on page 8

finitura vetro / glass finish

finitura struttura / frame finish

ARIA

design Giovanni Barbato 2017



BC/CM

BC/RA

NL

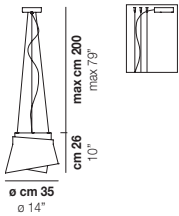

ARIA SP

codice / code	vetro / glass	struttura / frame	W	lumen @3000K	°K option	dimmer option	Ⓜ	m ³	EU cert.	International cert.	€
ARIA SP	BC/CM BC/RA	NL	E27	1x77W		DIM1	5,0	0,15	IP20	CE EAC	1.028,00

New

ARMONIA

design Francesco Lucchese 2019

finitura vetro / glass finish | finitura struttura / frame finish

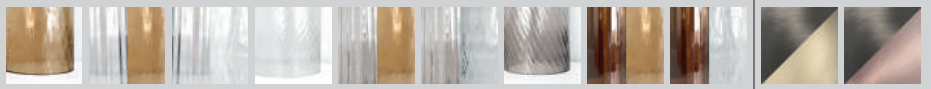

AM/RI CR/AM CR/CR CR/RI FU/AM FU/CR FU/RI TB/AM TB/CR N_0° N_R°

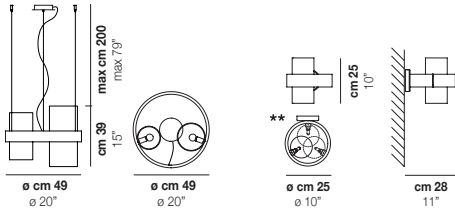

ARMONIA SP 50

ARMONIA AP 25

codice / code	vetro / glass	struttura / frame	W	lumen @3000K	°K option	dimmer option	Ⓜ	m³	EU cert.	International cert.	€
ARMONIASP50	CR/AM CR/CR FU/AM FU/CR TB/AM TB/CR	N_0° N_R°	E14	2×60W		DIM1	8,0	0,15	IP20	CE EAC	1.284,00
ARMONIAAP25	AM/RI CR/RI FU/RI	N_0° N_R°	G9	1×60W		DIM1	3,0	0,07	IP20	CE EAC	569,00

** Diffusore posizionabile frontalmente, lato dx e lato sx / Diffuser can be positioned frontally, right side and left side

* Vedi nota pagina 5 / See note on page 5

finitura vetro / glass finish | finitura struttura / frame finish

ASSIBA

design Mauro Olivieri 2011



BC/BT CR/BT MC/2 MC/3 CR

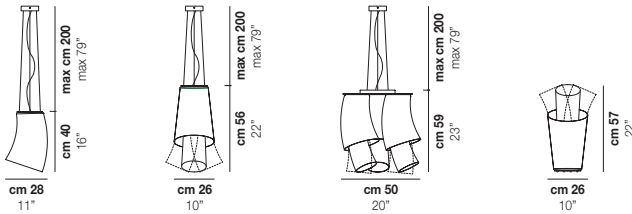

ASSIBA SP G

ASSIBA SP 2

ASSIBA SP 6

ASSIBA LT

codice / code	vetro / glass	struttura / frame	W	lumen @3000K	°K option	dimmer option	Ⓜ	m³	EU cert.	International cert.	€
ASSIBASP G	BC/BT CR/BT	CR	E27	1×77W		DIM1	7,5	0,16	IP20	CE CB EAC	1.044,00
ASSIBASP 2	BC/BT CR/BT MC/2 MC/3	CR	E27	1×77W		DIM1	8,0	0,21	IP20	CE CB EAC	1.070,00
ASSIBASP 6	BC/BT CR/BT MC/2 MC/3	CR	E27	3×77W		DIM1	25,0	0,64	IP20	CE CB EAC	3.014,00
ASSIBALT	BC/BT CR/BT MC/2 MC/3	CR	E27	1×77W		ON/OFF	7,5	0,21	IP20	CE CB EAC	962,00

finitura vetro / glass finish | finitura struttura / frame finish

AURORA

design Vistosi 1986



BC/CR BC BO

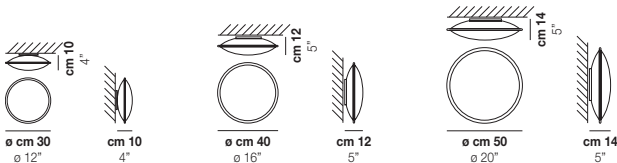

AURORA PP 30

AURORA PP 40

AURORA PP 50

codice / code	vetro / glass	struttura / frame	W	lumen @3000K	°K option	dimmer option	Ⓜ	m³	EU cert.	International cert.	€
AURORAPP 30	BC/CR	BC	E27	1×77W		DIM1	2,0	0,03	IP20	CE CB EAC	274,00
AURORAPP 30	BC/CR	BO	LED F	12W 1700	2700 3000	DIM2 DIM3	2,0	0,03	IP20	CE CB EAC	414,00
AURORAPP 40	BC/CR	BC	E27	1×77W		DIM1	3,0	0,05	IP20	CE CB EAC	355,00

codice / code	vetro / glass	struttura / frame	W	lumen @3000K	°K option	dimmer option		m³	EU cert.	International cert.	€	
AURORAPP 40	BC/CR	BO	LED F 12W	1700	2700 3000	DIM2 DIM3		3,0	0,05			495,00
AURORAPP 50	BC/CR	BC	E27 2x77W			DIM1		5,0	0,13			493,00
AURORAPP 50	BC/CR	BO	LED G 19W	2850	2700 3000	DIM2 DIM3		5,0	0,13			653,00

finitura vetro / glass finish | finitura struttura / frame finish

BACO

design Mauro Olivieri 1998

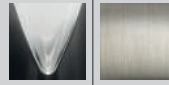

BC/SF | NI

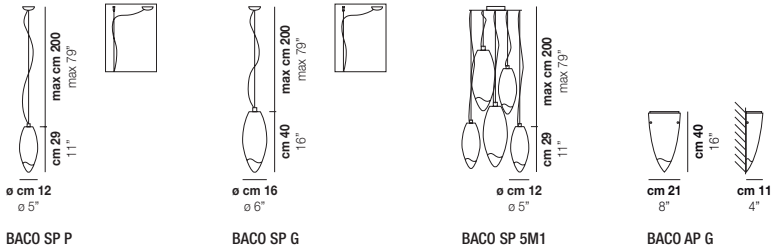
**BACO SP P****BACO SP G****BACO SP 5M1****BACO AP G**

codice / code	vetro / glass	struttura / frame	W	lumen @3000K	°K option	dimmer option		m³	EU cert.	International cert.	€	
BACOSP P	BC/SF	NI	E27 1x70W			DIM1		1,5	0,04			360,00
BACOSP G	BC/SF	NI	E27 1x70W			DIM1		3,0	0,07			467,00
BACOSP 5M1	BC/SF	NI	E27 5x70W			DIM1		7,0	0,18			1.384,00
BACO AP G	BC/SF		R7S 1x80W			DIM1		1,5	0,05			424,00

finitura vetro / glass finish | finitura struttura / frame finish

BALANCE

design Pio e Tito Toso 2011





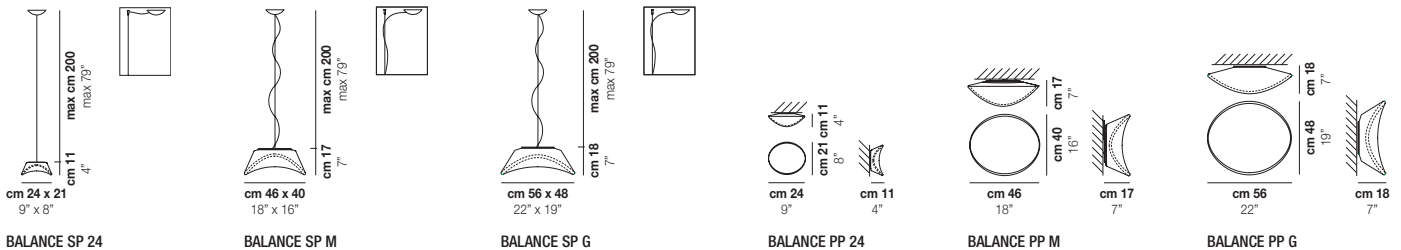















BC/LU | BC | BO | NIB

**BALANCE SP 24****BALANCE SP M****BALANCE SP G****BALANCE PP 24****BALANCE PP M****BALANCE PP G**

codice / code	vetro / glass	struttura / frame	W	lumen @3000K	°K option	dimmer option		m³	EU cert.	International cert.	€	
BALANCESP 24*	BC/LU	NIB	E14 1x46W			DIM1		3,0	0,03			243,00
BALANCESP M	BC/LU	NIB	E27 2x77W			DIM1		5,0	0,13			589,00
BALANCESP M	BC/LU	BO	LED G 19W	2850	2700 3000	DIM2 DIM3		5,0	0,13			749,00
BALANCESP G	BC/LU	NIB	E27 2x77W			DIM1		7,0	0,13			724,00
BALANCESP G	BC/LU	BO	LED G 19W	2850	2700 3000	DIM2 DIM3		7,0	0,13			884,00
BALANCEPP 24	BC/LU	BC	E14 1x46W			DIM1		1,0	0,03			169,00

* **Attenzione, modello modificato:** ora fornito con rosone metallico / **Attention, model modified:** now supplied with metal canopy

codice / code	vetro / glass	struttura / frame	W	lumen @3000K	°K option	dimmer option	 m³	EU cert.	International cert.	€
BALANCEPPM	B/CLU	BC	E27	2×77W		DIM1	4,0 0,10	 IP20	    	435,00
BALANCEPPM	B/CLU	BO	LED G	19W 2850	2700 3000	DIM2 DIM3	4,0 0,10	 IP20	 	595,00
BALANCEPPG	B/CLU	BC	E27	2×77W		DIM1	6,0 0,13	 IP20	    	561,00
BALANCEPPG	B/CLU	BO	LED G	19W 2850	2700 3000	DIM2 DIM3	6,0 0,13	 IP20	 	721,00

finitura vetro / glass finish | finitura struttura / frame finish

BIANCA









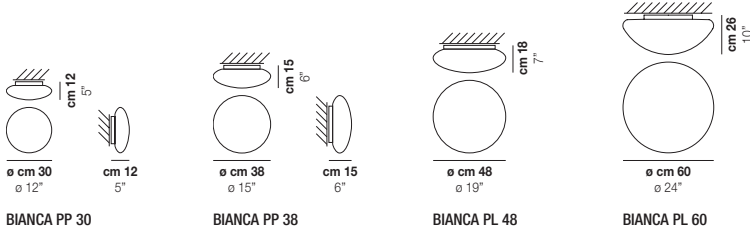







design Vistosi 1996



BC

BC



codice / code	vetro / glass	struttura / frame	W	lumen @3000K	°K option	dimmer option	 m³	EU cert.	International cert.	€
BIANCAPP 30	BC	BC	E27	1×77W		DIM1	2,0 0,03	 IP20	  	122,00
BIANCAPP 38	BC	BC	E27	1×77W		DIM1	3,5 0,05	 IP20	  	167,00
BIANCAPL 48	BC	BC	E27	3×77W		DIM1	4,0 0,10	 IP20	  	246,00
BIANCAPL 60	BC	BC	E27	3×77W		DIM1	8,0 0,22	 IP20	  	495,00

finitura vetro / glass finish | finitura struttura / frame finish

BISSA

design Vistosi 1968







BC/LU

BC



BISSA LT

codice / code	vetro / glass	struttura / frame	W	lumen @3000K	°K option	dimmer option	 m³	EU cert.	International cert.	€
F BISSALT	B/CLU	BC	G9	1×60W		ON/OFF	1,8 0,07	 IP20	 	515,00

finitura vetro / glass finish | finitura struttura / frame finish

BISSONA

design Vistosi 1968



BC/LU

BC



BISSONA LT

codice / code	vetro / glass	struttura / frame	W	lumen @3000K	°K option	dimmer option	 m³	EU cert.	International cert.	€
BISSONALT	B/CLU	BC	G9	1×60W		ON/OFF	4,5 0,11	 IP20	 	607,00

finitura vetro / glass finish | finitura struttura / frame finish

BOLLE

design Barbara Maggiolo 2003

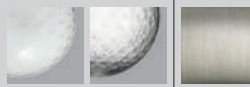

BC/BO | CR/BO | NI

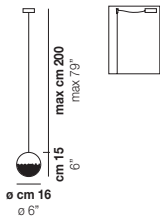

BOLLE SP P

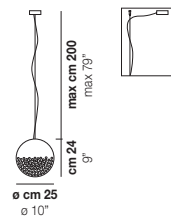

BOLLE SP G

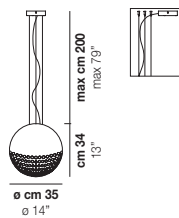

BOLLE SP 35

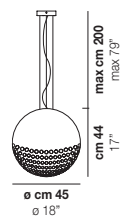

BOLLE SP 45

codice / code	vetro / glass	struttura / frame	W	lumen @3000K	°K option	dimmer option	IP	m ³	EU cert.	International cert.	€	
BOLLESPP*	BC/BO CR/BO	NI	G9	1×60W		DIM1	1,5	0,04	IP20	CE CB EAC	304,00	
BOLLESPP	BC/BO CR/BO	NI	LED B	9W	1200	2700 3000	DIM2 DIM3	1,5	0,04	IP20	CE EAC	454,00
BOLLESPG	BC/BO CR/BO	NI	E27	1×77W		DIM1	3,5	0,05	IP20	CE CB EAC	440,00	
BOLLESPG	BC/BO CR/BO	NI	LED C	12W	1600	2700 3000	DIM2 DIM3	3,5	0,05	IP20	CE EAC	590,00
BOLLESP35	BC/BO CR/BO	NI	E27	1×77W		DIM1	7,0	0,10	IP20	CE CB EAC	470,00	
BOLLESP35	BC/BO CR/BO	NI	LED C	12W	1600	2700 3000	DIM2 DIM3	7,0	0,10	IP20	CE EAC	620,00
F BOLLESP45	BC/BO CR/BO	NI	E27	3×77W		DIM1	9,0	0,25	IP20	CE CB EAC	764,00	

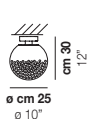
* **Attenzione, modello modificato:** ora fornito con rosone metallico / **Attention, model modified:** now supplied with metal canopy

BOLLE PL G

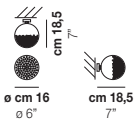

BOLLE FA P



BOLLE LT P

codice / code	vetro / glass	struttura / frame	W	lumen @3000K	°K option	dimmer option	IP	m ³	EU cert.	International cert.	€	
BOLLEPLG	BC/BO CR/BO	NI	E27	1×77W		DIM1	4,4	0,05	IP20	CE CB EAC	571,00	
BOLLEFAP	BC/BO CR/BO	NI	G9	1×60W		DIM1	2,0	0,04	IP20	CE CB EAC	328,00	
BOLLEFAP	BC/BO CR/BO	NI	LED D	9W	1200	2700 3000	DIM2 DIM3	2,0	0,04	IP20	CE EAC	488,00
BOLLELP	BC/BO CR/BO	NI	G9	1×60W		ON/OFF	2,0	0,04	IP20	CE EAC	356,00	

finitura vetro / glass finish | finitura struttura / frame finish

BOT

design Gregorio Spini 2011



BC/CR | BC | BO

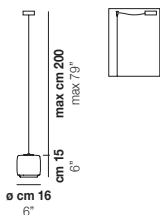

BOT SP 16

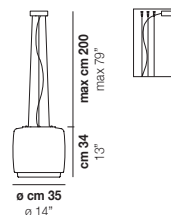

BOT SP 35

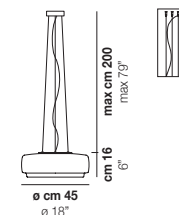

BOT SP 45

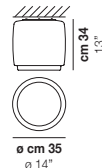

BOT PL 35

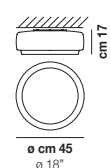



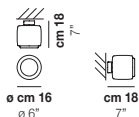

























BOT PP 45



BOT FA 16

codice / code	vetro / glass	struttura / frame	W	lumen @3000K	°K option	dimmer option	IP	m ³	EU cert.	International cert.	€	
BOT SP 16*	BC/CR	BC	G9	1×60W		DIM1	2,0	0,04	IP20	CE CB EAC	404,00	
BOT SP 35	BC/CR	BC	E27	3×77W		DIM1	9,5	0,19	IP20	CE CB EAC	841,00	
BOT SP 35	BC/CR	BO	LED G	19W	2850	2700 3000	DIM2 DIM3	9,5	0,19	IP20	CE EAC	1.011,00

codice / code	vetro / glass	struttura / frame	W	lumen @3000K	°K option	dimmer option		m ³	EU cert.	International cert.	€
BOT SP 45	BC/CR	BC	E27	2×77W		DIM1		10,5 0,14		   	885,00
BOT SP 45	BC/CR	BO	LED G	19W 2850	2700 3000	DIM2 DIM3		10,5 0,14		  	1.055,00
F BOT PL 35	BC/CR	BC	E27	3×77W		DIM1		9,5 0,16		   	619,00
BOT PP 45	BC/CR	BC	E27	2×77W		DIM1		10,5 0,11		   	771,00
BOT PP 45	BC/CR	BO	LED G	19W 2850	2700 3000	DIM2 DIM3		10,5 0,11		  	931,00
F BOT FA 16	BC/CR	BC	G9	1×60W		DIM1		2,0 0,04		  	374,00

* **Attenzione, modello modificato:** ora fornito con rosone metallico / **Attention, model modified:** now supplied with metal canopy

finitura vetro / glass finish | finitura struttura / frame finish

CANDELA

design Vistosi 2010

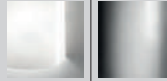

BC/LU | CR

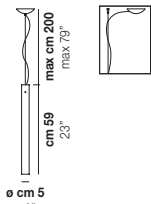

CANDELA SP

codice / code	vetro / glass	struttura / frame	W	lumen @3000K	°K option	dimmer option		m ³	EU cert.	International cert.	€
CANDELASP	BC/LU	CR	G9	1×60W		DIM1		1,5 0,05		   	305,00

finitura vetro / glass finish | finitura struttura / frame finish

CLEO

design Barbara Maggiolo 2009



BC/LU | NI

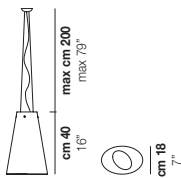

CLEO SP

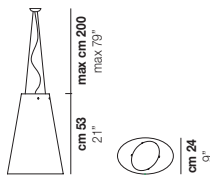



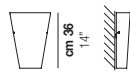



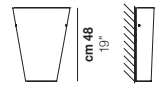













CLEO SP G



CLEO AP



CLEO AP G

codice / code	vetro / glass	struttura / frame	W	lumen @3000K	°K option	dimmer option		m ³	EU cert.	International cert.	€
F CLEOSP	BC/LU	NI	E27	1×77W		DIM1		3,1 0,11		   	368,00
F CLEOSPG	BC/LU	NI	E27	1×77W		DIM1		10,0 0,20		   	677,00
F CLEOAP	BC/LU	NI	E27	1×77W		DIM1		2,2 0,05		   	162,00
F CLEOAPG	BC/LU	NI	E27	2×77W		DIM1		3,0 0,13		  	322,00

finitura vetro / glass finish

finitura struttura / frame finish

CLOTH

design Romani Saccani Architetti Associati 2009

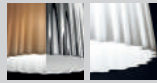

BC/CM

BC/ST

CR

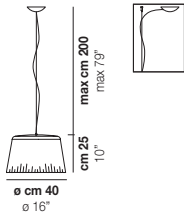

CLOTH SP G

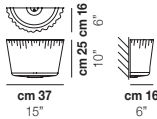

CLOTH AP G

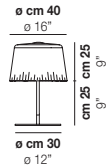

CLOTH LT G

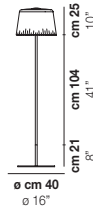

CLOTH PT G

codice / code	vetro / glass	struttura / frame	W	lumen @3000K	°K option	dimmer option	⚡	m³	EU cert.	International cert.	€	
CLOTHSPG	BC/ST	CR	E27	1×77W		DIM1	6,5	0,11	⚡ IP20	CE CB EAC	372,00	
CLOTHSPG	BC/CM	CR	E27	1×77W		DIM1	6,5	0,11	⚡ IP20	CE CB EAC	497,00	
CLOTHSPG	BC/ST	CR	LED C	12W	1600	DIM2 DIM3	2700 3000	6,5	0,11	⚡ IP20	CE EAC	534,00
CLOTHSPG	BC/CM	CR	LED C	12W	1600	DIM2 DIM3	2700 3000	6,5	0,11	⚡ IP20	CE EAC	659,00
CLOTHAPG	BC/ST	CR	E27	1×77W		DIM1	3,5	0,11	⚡ IP20	CE CB EAC	363,00	
CLOTHAPG	BC/CM	CR	E27	1×77W		DIM1	3,5	0,11	⚡ IP20	CE EAC	448,00	
F CLOTHLTG	BC/ST	CR	E27	3×77W		ON/OFF	9,0	0,22	⚡ IP20	CE EAC	724,00	
F CLOTHLTG	BC/CM	CR	E27	3×77W		ON/OFF	9,0	0,22	⚡ IP20	CE EAC	841,00	
F CLOTHPTG	BC/ST	CR	E27	3×77W		ON/OFF	17,0	0,29	⚡ IP20	CE EAC	912,00	
F CLOTHPTG	BC/CM	CR	E27	3×77W		ON/OFF	17,0	0,29	⚡ IP20	CE EAC	1.048,00	

finitura vetro / glass finish

CORNER

design Vistosi 1993



AM/LU

AM/ST

BC/LU

BC/ST

FU/LU

FU/ST

TB/LU

TB/ST

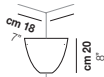

CORNER AP

codice / code	vetro / glass	struttura / frame	W	lumen @3000K	°K option	dimmer option	⚡	m³	EU cert.	International cert.	€
CORNERAP	BC/LU BC/ST		E27	1×77W		DIM1	1,0	0,03	⚡ IP20	CE CB EAC	154,00
F CORNERAP	AM/LU AM/ST FU/LU FU/ST TB/LU TB/ST		E27	1×77W		DIM1	1,0	0,03	⚡ IP20	CE CB EAC	180,00

finitura vetro / glass finish

finitura struttura / frame finish

CRISTALLINA

design Romani Saccani Architetti Associati 2017

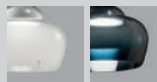

BC/SF

NE/SF

BO

NEO

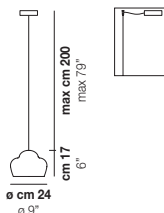

CRISTALLINA SP

codice / code	vetro / glass	struttura / frame	W	lumen @3000K	°K option	dimmer option	⚡	m³	EU cert.	International cert.	€	
CRISTALLINASP*	BC/SF	BO	LED 01	8,5W	1200	DIM2 DIM3	2700 3000	3,0	0,07	⚡ IP20	CE EAC	528,00

codice / code	vetro / glass	struttura / frame	W	lumen @3000K	°K option	dimmer option	IP	m³	EU cert.	International cert.	€	
CRISTALLINASP*	NE/SF	NEO	LED 01 8,5W	1200	2700 3000	DIM2 DIM3	3,0	0,07	IP20	CE	ERL	528,00

* **Attenzione, modello modificato:** ora fornito con rosone metallico / **Attention, model modified:** now supplied with metal canopy

finitura vetro / glass finish

DAFNE

design Vistosi 1993



AM/LU AM/ST BC/LU BC/ST FU/LU FU/ST TB/LU TB/ST

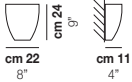

DAFNE AP

codice / code	vetro / glass	struttura / frame	W	lumen @3000K	°K option	dimmer option	IP	m³	EU cert.	International cert.	€	
DAFNEAP	BC/LU BC/ST		E27 1x77W			DIM1	1,0	0,03	IP20	CE CB	ERL	143,00
F DAFNEAP	AM/LU AM/ST FU/LU FU/ST TB/LU TB/ST		E27 1x77W			DIM1	1,0	0,03	IP20	CE CB	ERL	169,00

finitura vetro / glass finish | finitura struttura / frame finish

DAMASCO

design Paolo Crepax 2003



CR/AM CR/CR NI

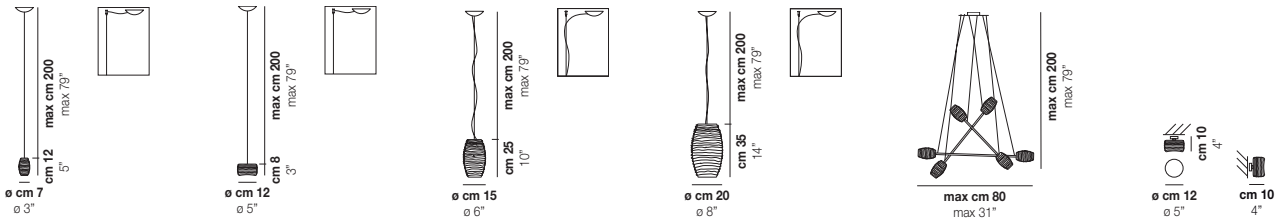

DAMASCO SP P

DAMASCO SP C

DAMASCO SP M

DAMASCO SP G

DAMASCO SP 6 P

DAMASCO FA C

codice / code	vetro / glass	struttura / frame	W	lumen @3000K	°K option	dimmer option	IP	m³	EU cert.	International cert.	€	
DAMASCOSP*	CR/AM CR/CR	NI	G9 1x60W			DIM1	1,0	0,01	IP20	CE CB	ERL	262,00
DAMASCOSP	CR/AM CR/CR	NI	LED A 9W	1200	2700 3000	DIM2 DIM3	1,0	0,01	IP20	CE	ERL	412,00
DAMASCOPC*	CR/AM CR/CR	NI	G9 1x60W			DIM1	1,0	0,01	IP20	CE CB	ERL	297,00
DAMASCOPC	CR/AM CR/CR	NI	LED B 9W	1200	2700 3000	DIM2 DIM3	1,0	0,01	IP20	CE	ERL	447,00
DAMASCOPM	CR/AM CR/CR	NI	E27 1x77W			DIM1	5,0	0,08	IP20	CE CB	ERL	524,00
DAMASCOPM	CR/AM CR/CR	NI	LED C 12W	1600	2700 3000	DIM2 DIM3	5,0	0,08	IP20	CE	ERL	674,00
DAMASCOPG	CR/AM CR/CR	NI	E27 1x77W			DIM1	5,0	0,08	IP20	CE CB	ERL	752,00
DAMASCOPG	CR/AM CR/CR	NI	LED C 12W	1600	2700 3000	DIM2 DIM3	5,0	0,08	IP20	CE	ERL	902,00
DAMASCOSP6P	CR/AM CR/CR	NI	G9 6x60W			DIM1	4,5	0,13	IP20	CE	ERL	1.479,00
DAMASCOFAC	CR/AM CR/CR	NI	G9 1x60W			DIM1	1,0	0,01	IP20	CE CB	ERL	286,00
DAMASCOFAC	CR/AM CR/CR	NI	LED D 9W	1200	2700 3000	DIM2 DIM3	1,0	0,01	IP20	CE	ERL	446,00

* **Attenzione, modello modificato:** ora fornito con rosone metallico / **Attention, model modified:** now supplied with metal canopy

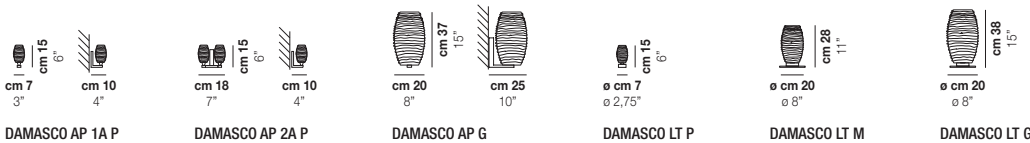

DAMASCO AP 1A P

DAMASCO AP 2A P

DAMASCO AP G

DAMASCO LT P

DAMASCO LT M

DAMASCO LT G

codice / code	vetro / glass	struttura / frame	W	lumen @3000K	°K option	dimmer option	IP	m³	EU cert.	International cert.	€	
DAMASCOAP1AP	CR/AM CR/CR	NI	G9 1x60W			DIM1	1,0	0,01	IP20	CE	ERL	393,00
DAMASCOAP2AP	CR/AM CR/CR	NI	G9 2x60W			DIM1	1,0	0,03	IP20	CE	ERL	571,00
DAMASCOAPG	CR/AM CR/CR	NI	E27 1x77W			DIM1	4,5	0,08	IP20	CE	ERL	920,00

codice / code	vetro / glass	struttura / frame	W	lumen @3000K	°K option	dimmer option	Ⓜ	m³	EU cert.	International cert.	€
DAMASCOLTP	CR/AM CR/CR	NI	G9	1×60W		ON/OFF	1,5	0,01	IP20	CE EAC PS	333,00
DAMASCOLTM	CR/AM CR/CR	NI	E27	1×77W		ON/OFF	5,5	0,09	IP20	CE CB EAC PS	654,00
DAMASCOLTG	CR/AM CR/CR	NI	E27	1×77W		ON/OFF	5,5	0,09	IP20	CE CB EAC PS	858,00

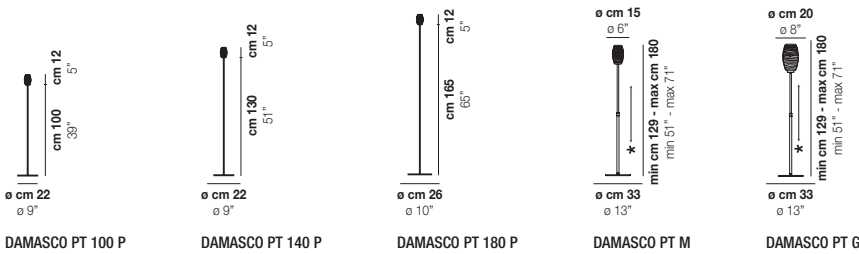

codice / code	vetro / glass	struttura / frame	W	lumen @3000K	°K option	dimmer option	Ⓜ	m³	EU cert.	International cert.	€
DAMASCOPT 100P	CR/AM CR/CR	NI	G9	1×60W		ON/OFF	4,0	0,10	IP20	CE EAC PS	486,00
DAMASCOPT 140P	CR/AM CR/CR	NI	G9	1×60W		ON/OFF	4,0	0,10	IP20	CE EAC PS	533,00
DAMASCOPT 180P	CR/AM CR/CR	NI	G9	1×60W		ON/OFF	5,0	0,14	IP20	CE EAC PS	614,00
DAMASCOPT M	CR/AM CR/CR	NI	E27	1×77W		ON/OFF	13,0	0,17	IP20	CE CB EAC PS	1.141,00
DAMASCOPT G	CR/AM CR/CR	NI	E27	1×77W		ON/OFF	13,0	0,17	IP20	CE CB EAC PS	1.479,00

* Lo stelo è regolabile in altezza / The height of the base may be adjusted

finitura vetro / glass finish | finitura struttura / frame finish

DIADEMA

design Romani Sacconi Architetti Associati 2005

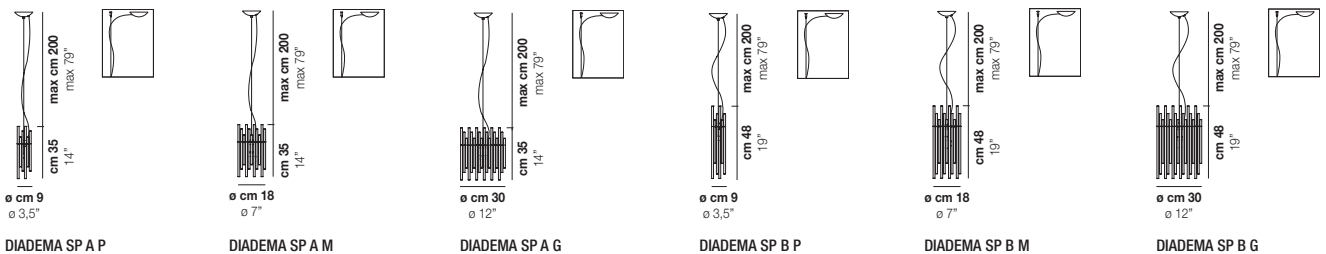
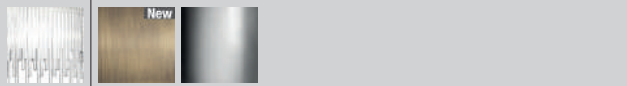

codice / code	vetro / glass	struttura / frame	W	lumen @3000K	°K option	dimmer option	Ⓜ	m³	EU cert.	International cert.	€
DIADEMASP A P	CR	BS CR	G9	1×60W		DIM1	6,0	0,05	IP20	CE EAC PS	352,00
DIADEMASP A P	CR	BS CR	NEW LED C	12W 1600	2700 3000	DIM2 DIM3	6,0	0,05	IP20	CE EAC PS	502,00
DIADEMASP A M	CR	BS CR	E27	1×77W		DIM1	6,0	0,06	IP20	CE CB EAC PS	555,00
DIADEMASP A M	CR	BS CR	NEW LED C	12W 1600	2700 3000	DIM2 DIM3	6,0	0,06	IP20	CE EAC PS	705,00
DIADEMASP A G	CR	BS CR	E27	1×77W		DIM1	6,0	0,12	IP20	CE CB EAC PS	776,00
DIADEMASP A G	CR	BS CR	NEW LED C	12W 1600	2700 3000	DIM2 DIM3	6,0	0,12	IP20	CE EAC PS	926,00
DIADEMASP B P	CR	BS CR	G9	1×60W		DIM1	6,0	0,05	IP20	CE EAC PS	412,00
DIADEMASP B P	CR	BS CR	NEW LED C	12W 1600	2700 3000	DIM2 DIM3	6,0	0,05	IP20	CE EAC PS	562,00
DIADEMASP B M	CR	BS CR	E27	1×77W		DIM1	8,0	0,06	IP20	CE CB EAC PS	695,00
DIADEMASP B M	CR	BS CR	NEW LED C	12W 1600	2700 3000	DIM2 DIM3	8,0	0,06	IP20	CE EAC PS	845,00
DIADEMASP B G	CR	BS CR	E27	1×77W		DIM1	10,0	0,12	IP20	CE CB EAC PS	1.004,00
DIADEMASP B G	CR	BS CR	NEW LED C	12W 1600	2700 3000	DIM2 DIM3	10,0	0,12	IP20	CE EAC PS	1.154,00

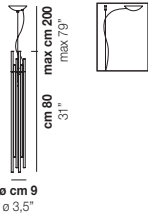

DIADEMA SP C P

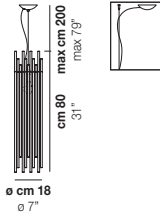

DIADEMA SP C M

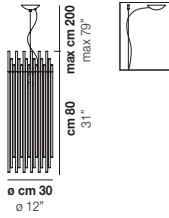

DIADEMA SP C G

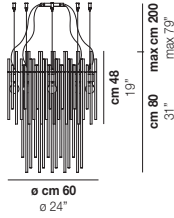

DIADEMA SP 60 B

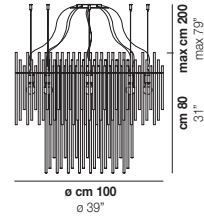

DIADEMA SP C_2

codice / code	vetro / glass	struttura / frame	W	lumen @3000K	°K option	dimmer option	m³	EU cert.	International cert.	€
DIADEMASPCP	CR	BS CR	G9	1x60W		DIM1	6,0	IP20	CE EAC CCC PS	486,00
DIADEMASPCP	CR	BS CR	LED C	12W	1600	DIM2 DIM3	6,0	IP20	CE EAC CCC PS	636,00
DIADEMASPCM	CR	BS CR	E27	1x77W		DIM1	6,0	IP20	CE EAC CB CCC PS	887,00
DIADEMASPCM	CR	BS CR	LED C	12W	1600	DIM2 DIM3	6,0	IP20	CE EAC CB CCC PS	1.037,00
DIADEMASPCG	CR	BS CR	E27	1x77W		DIM1	10,0	IP20	CE EAC CB CCC PS	1.274,00
DIADEMASPCG	CR	BS CR	LED C	12W	1600	DIM2 DIM3	10,0	IP20	CE EAC CB CCC PS	1.424,00
DIADEMASP60B	CR	BS CR	E27	8x77W		DIM1	45,0	IP20	CE EAC CB CCC PS	3.568,00
DIADEMASPC_2	CR	BS CR	E27	8x77W		DIM1	50,0	IP20	CE EAC CB CCC PS	5.424,00

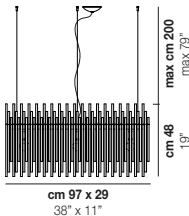

DIADEMA SP K3

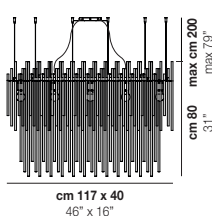

DIADEMA SP O2

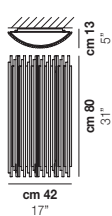

DIADEMA PL 80

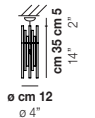

DIADEMA FA P

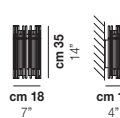

DIADEMA AP P

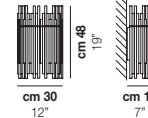

DIADEMA AP G

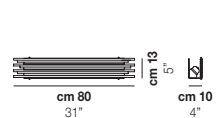

DIADEMA AP L

codice / code	vetro / glass	struttura / frame	W	lumen @3000K	°K option	dimmer option	m³	EU cert.	International cert.	€
DIADEMASPK3	CR	BS CR	E27	3x77W		DIM1	33,0	IP20	CE EAC CB CCC PS	3.078,00
DIADEMASPO2	CR	BS CR	E27	10x77W		DIM1	50,0	IP20	CE EAC CB CCC PS	4.337,00
DIADEMAPL80	CR	BS CR	R7S	2x120W		DIM1	15,0	IP20	CE EAC CCC PS	1.370,00
DIADEMAFAP	CR	BS CR	G9	1x60W		DIM1	5,0	IP20	CE EAC CCC PS	412,00
DIADEMAAPP	CR	BS CR	G9	2x60W		DIM1	4,5	IP20	CE EAC CCC PS	486,00
DIADEMAAPG	CR	BS CR	E27	2x77W		DIM1	4,5	IP20	CE EAC CCC PS	713,00
DIADEMAAPL	CR	BS CR	R7S	2x80W		DIM1	4,5	IP20	CE EAC CCC PS	805,00

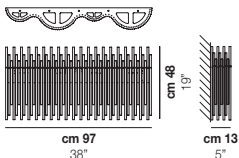

DIADEMA AP K3

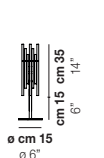

DIADEMA LT A P

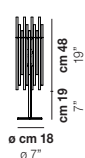

DIADEMA LT B G

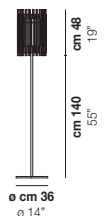

DIADEMA PT B G

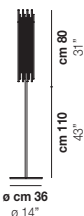

DIADEMA PT C M

codice / code	vetro / glass	struttura / frame	W	lumen @3000K	°K option	dimmer option	m³	EU cert.	International cert.	€
DIADEMAAPK3	CR	BS CR	G9	4x60W		DIM1	15,0	IP20	CE EAC CCC PS	1.750,00
DIADEMALTAP	CR	BS CR	G9	1x60W		ON/OFF	3,0	IP20	CE EAC CCC PS	514,00
DIADEMALTBG	CR	BS CR	G9	1x60W		ON/OFF	7,0	IP20	CE EAC CCC PS	754,00
DIADEMAPTBG	CR	BS CR	G9	3x60W		ON/OFF*	21,0	IP20	CE EAC CCC PS	1.766,00
DIADEMAPTCM	CR	BS CR	G9	3x60W		ON/OFF*	21,0	IP20	CE EAC CCC PS	1.655,00

* Vedi nota pagina 8 / See note on page 8

finitura vetro / glass finish | finitura struttura / frame finish

DIAMANTE

design Barbara Maggiolo 2003

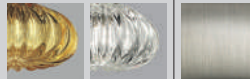

AM | CR | NI

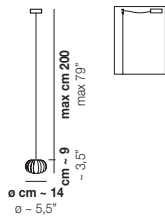

DIAMANTE SP P

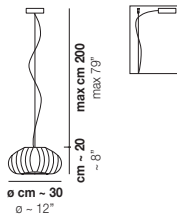

DIAMANTE SP G

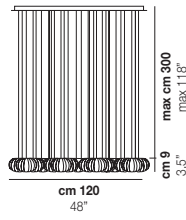

DIAMANTE SP 36

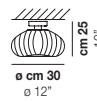

DIAMANTE PL G

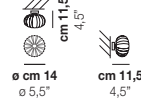

DIAMANTE FA

codice / code	vetro / glass	struttura / frame	W	lumen @3000K	°K option	dimmer option	m³	EU cert.	International cert.	€
DIAMANTESPP*	AM CR	NI	G9	1×60W		DIM1	1,0	IP20	CE CB EAC PS	298,00
DIAMANTESPP	AM CR	NI	LED B	9W	1200	2700 3000 DIM2 DIM3	1,0	IP20	CE EAC	448,00
DIAMANTESPG	AM CR	NI	E27	1×77W		DIM1	6,0	IP20	CE CB EAC PS	698,00
DIAMANTESPG	AM CR	NI	LED C	12W	1600	2700 3000 DIM2 DIM3	6,0	IP20	CE EAC	848,00
DIAMANTESP36	AM CR	NI	G9	36×60W		DIM1	35	IP20	CE EAC PS	10.812,00
DIAMANTEPLG	AM CR	NI	E27	1×77W		DIM1	5,0	IP20	CE EAC PS	704,00
DIAMANTEFA	AM CR	NI	G9	1×60W		DIM1	1,0	IP20	CE CB EAC PS	294,00
DIAMANTEFA	AM CR	NI	LED D	9W	1200	2700 3000 DIM2 DIM3	1,0	IP20	CE EAC	454,00

* **Attenzione, modello modificato:** ora fornito con rosone metallico / **Attention, model modified:** now supplied with metal canopy

finitura vetro / glass finish | finitura struttura / frame finish

DRESS

design Vistosi 2005



BC/LU | CR

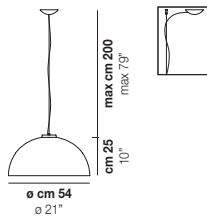

DRESS SP G

codice / code	vetro / glass	struttura / frame	W	lumen @3000K	°K option	dimmer option	m³	EU cert.	International cert.	€
DRESSSPG	BC/LU	CR	E27	1×77W		DIM1	4,5	IP20	CE CB EAC PS	610,00
DRESSSPG	BC/LU	CR	LED C	12W	1600	2700 3000 DIM2 DIM3	4,5	IP20	CE EAC	760,00

ECOS

design Renato Toso, Noti Massari & Associati 2007

finitura vetro / glass finish

finitura struttura / frame finish

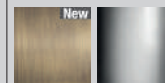

BC/RI

CR/RI

BS

CR

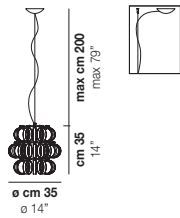

ECOS SP 35

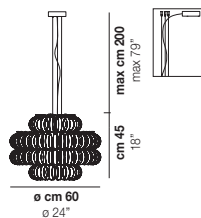

ECOS SP 60C

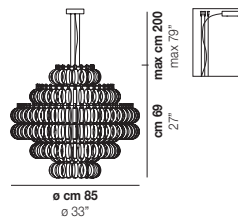

ECOS SP 90

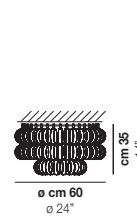

ECOS PL 60A

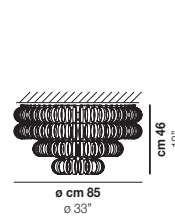

ECOS PL 90

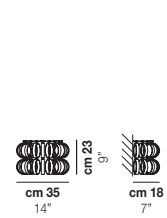

ECOS AP 35

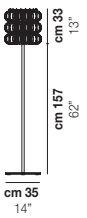

ECOS PT 35

codice / code	vetro / glass	struttura / frame	W	lumen @3000K	°K option	dimmer option	m³	EU cert.	International cert.	€
ECOSSP35	BC/RI CR/RI	BS CR	E27	1x77W		DIM1	5,0 0,14 \perp IP20			1.134,00
ECOSSP60C	BC/RI CR/RI	BS CR	E27	4x77W		DIM1	15,0 0,24 \perp IP20			4.182,00
ECOSSP90	BC/RI CR/RI	BS CR	E27	5x77W		DIM1	24,0 0,52 \perp IP20			8.846,00
ECOSPL60A	BC/RI CR/RI	BS CR	E27	3x77W		DIM1	13,0 0,24 \perp IP20			4.182,00
ECOSPL90	BC/RI CR/RI	BS CR	E27	5x77W		DIM1	18,0 0,46 \perp IP20			8.607,00
ECOSAP35	BC/RI CR/RI	BS CR	G9	2x60W		DIM1	2,5 0,05 \perp IP20			867,00
ECOSPT35	BC/RI CR/RI	BS CR	E27	1x77W		ON/OFF*	21,0 0,24 \square IP20			2.032,00

* Vedi nota pagina 8 / See note on page 8

ESSENCE

design atelier oi 2015

finitura vetro / glass finish

finitura struttura / frame finish



CR/SF

AB

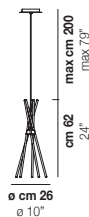

ESSENCE SP

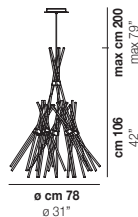

ESSENCE SP 5

codice / code	vetro / glass	struttura / frame	W	lumen @3000K	°K option	dimmer option	m³	EU cert.	International cert.	€
ESSENCE SP	CR/SF	AB	NEW LED 20	1x5W 600	2700 3000	DIM2 DIM3	4,0 0,07 \perp IP20			514,00
ESSENCE SP 5	CR/SF	AB	NEW LED 20	5x5W 3000	2700 3000	DIM2 DIM3	7,5 0,43 \perp IP20			3.370,00

finitura vetro / glass finish

finitura struttura / frame finish

FEREA

design Babled & Co. 2009



BC/ST

BC

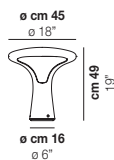

FEREA LT

codice / code	vetro / glass	struttura / frame	W	lumen @3000K	°K option	dimmer option	m³	EU cert.	International cert.	€
FEREALT	BC/ST	BC	E27	1x77W		ON/OFF*	6,5 0,24 \perp IP20			979,00

* Vedi nota pagina 8 / See note on page 8

FUTURA

design Hangar Group 2015

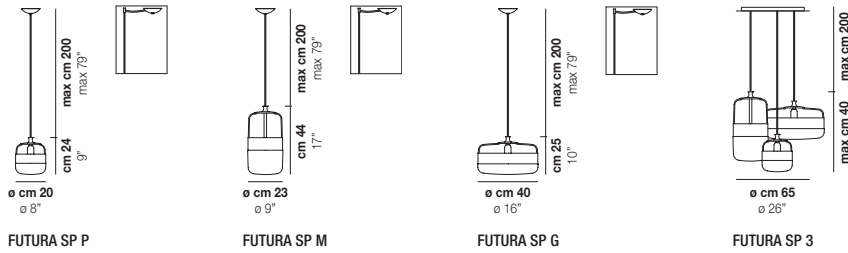

codice / code	vetro / glass	struttura / frame	W	lumen @3000K	°K option	dimmer option	Δ _{RA}	m ³	EU cert.	International cert.	€	
FUTURASP P	AM/OT BC/NE CR/NE FU/MA	NE	E27	1x77W		DIM1	3,5	0,07	IP20	CE CB EAC	430,00	
FUTURASP P	CR/RA	R_N	E27	1x77W		DIM1	3,5	0,07	IP20	CE CB EAC	466,00	
FUTURASP P	AM/OT BC/NE CR/NE FU/MA	NE	LED C	12W	1600	2700 3000	DIM2 DIM3	3,5	0,07	IP20	CE EAC	580,00
FUTURASP P	CR/RA	R_N	LED C	12W	1600	2700 3000	DIM2 DIM3	3,5	0,07	IP20	CE EAC	616,00
FUTURASPM	AM/OT BC/NE CR/NE FU/MA	NE	E27	1x77W		DIM1	5,0	0,16	IP20	CE CB EAC	630,00	
FUTURASPM	CR/RA	R_N	E27	1x77W		DIM1	5,0	0,16	IP20	CE CB EAC	690,00	
FUTURASPM	AM/OT BC/NE CR/NE FU/MA	NE	LED C	12W	1600	2700 3000	DIM2 DIM3	5,0	0,16	IP20	CE EAC	780,00
FUTURASPM	CR/RA	R_N	LED C	12W	1600	2700 3000	DIM2 DIM3	5,0	0,16	IP20	CE EAC	840,00
FUTURASPG	AM/OT BC/NE CR/NE FU/MA	NE	E27	1x77W		DIM1	7,5	0,16	IP20	CE CB EAC	775,00	
FUTURASPG	CR/RA	R_N	E27	1x77W		DIM1	7,5	0,16	IP20	CE CB EAC	840,00	
FUTURASPG	AM/OT BC/NE CR/NE FU/MA	NE	LED C	12W	1600	2700 3000	DIM2 DIM3	7,5	0,16	IP20	CE EAC	925,00
FUTURASPG	CR/RA	R_N	LED C	12W	1600	2700 3000	DIM2 DIM3	7,5	0,16	IP20	CE EAC	990,00
FUTURASP 3	MC/1	NE	E27	3x77W		DIM1	19,0	0,50	IP20	CE CB EAC	2.226,00	
FUTURASP 3	CR/RA	R_N	E27	3x77W		DIM1	19,0	0,50	IP20	CE CB EAC	2.361,00	

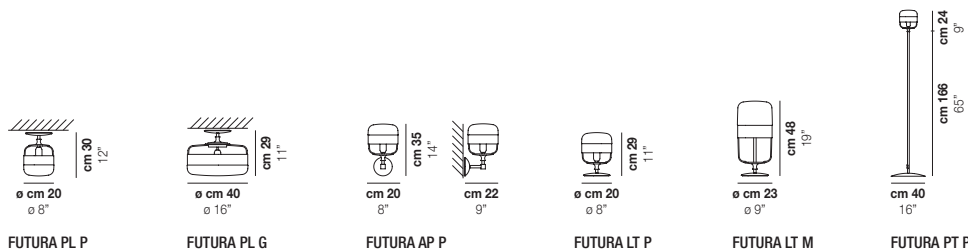

codice / code	vetro / glass	struttura / frame	W	lumen @3000K	°K option	dimmer option	Δ _{RA}	m ³	EU cert.	International cert.	€
FUTURAPLP	AM/OT BC/NE CR/NE CR/RA FU/MA	NE	E27	1x77W		DIM1	3,5	0,10	IP20	CE EAC	435,00
FUTURAPLG	AM/OT BC/NE CR/NE CR/RA FU/MA	NE	E27	1x77W		DIM1	7,0	0,16	IP20	CE EAC	796,00
FUTURAAPP	AM/OT BC/NE CR/NE CR/RA FU/MA	NE	E27	1x77W		DIM1	3,5	0,07	IP20	CE EAC	458,00
FUTURALTP	AM/OT BC/NE CR/NE CR/RA FU/MA	NE	E27	1x77W		ON/OFF	5,0	0,16	IP20	CE CB EAC	505,00
FUTURALTM	AM/OT BC/NE CR/NE CR/RA FU/MA	NE	E27	1x77W		ON/OFF	8,0	0,16	IP20	CE CB EAC	670,00
FUTURAPT P	AM/OT BC/NE CR/NE CR/RA FU/MA	NE	E27	1x77W		ON/OFF	13,0	0,25	IP20	CE CB EAC	810,00

* Finitura vetro combinata con anello metallico / Glass finish combined with metal ring

• MC/1 vetro e fascia metallica AM/OT+BC/NE+FU/MA, struttura NE, cavo nero / MC/1 glass and metal ring AM/OT+BC/NE+FU/MA, frame NE, black cable

GIOGALI

design Angelo Mangiarotti 1967

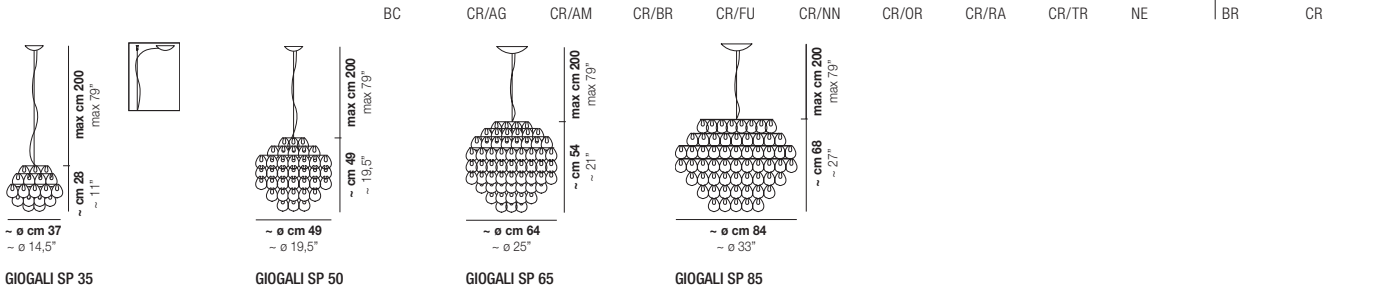
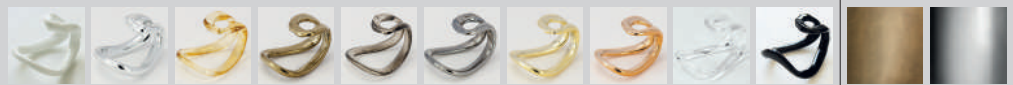

codice / code	vetro / glass	struttura / frame	W	°K option	dimmer option	Δm	m ³	EU cert.	International cert.	€
GIOGALI SP 35*	CR/TR	BR CR	E27 1x77W		DIM1	5,0	0,10	⊥ IP20	CE CB EAC ENEC PS	585,00
GIOGALI SP 35*	BC CR/AG CR/AM CR/BR CR/FU CR/NN CR/OR CR/RA NE	BR CR	E27 1x77W		DIM1	5,0	0,10	⊥ IP20	CE CB EAC ENEC PS	765,00
GIOGALI SP 50*	CR/TR	BR CR	E27 3x77W		DIM1	20,0	0,27	⊥ IP20	CE CB EAC ENEC PS	1.455,00
GIOGALI SP 50*	BC CR/AG CR/AM CR/BR CR/FU CR/NN CR/OR CR/RA NE	BR CR	E27 3x77W		DIM1	20,0	0,27	⊥ IP20	CE CB EAC ENEC PS	2.085,00
GIOGALI SP 65*	CR/TR	BR CR	E27 4x77W		DIM1	25,0	0,36	⊥ IP20	CE CB EAC ENEC PS	2.310,00
GIOGALI SP 65*	BC CR/AG CR/AM CR/BR CR/FU CR/NN CR/OR CR/RA NE	BR CR	E27 4x77W		DIM1	25,0	0,36	⊥ IP20	CE CB EAC ENEC PS	3.235,00
GIOGALI SP 85*	CR/TR	BR CR	E27 5x77W		DIM1	35,0	0,72	⊥ IP20	CE CB EAC ENEC PS	3.260,00
GIOGALI SP 85*	BC CR/AG CR/AM CR/BR CR/FU CR/NN CR/OR CR/RA NE	BR CR	E27 5x77W		DIM1	35,0	0,72	⊥ IP20	CE CB EAC ENEC PS	4.530,00

* Attenzione modello modificato. Kit rosone e catena disponibile su richiesta € 238,00 / Attention, model modified. Canopy and chain kit is available on request € 238,00

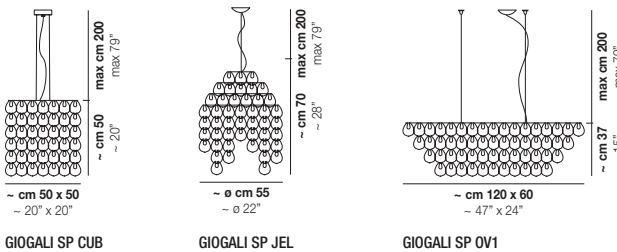

codice / code	vetro / glass	struttura / frame	W	°K option	dimmer option	Δm	m ³	EU cert.	International cert.	€
GIOGALI SP CUB	CR/TR	BR CR	E27 3x77W		DIM1	29,0	0,38	⊥ IP20	CE CB EAC ENEC PS	2.595,00
GIOGALI SP CUB	BC CR/AG CR/AM CR/BR CR/FU CR/NN CR/OR CR/RA NE	BR CR	E27 3x77W		DIM1	29,0	0,38	⊥ IP20	CE CB EAC ENEC PS	3.725,00
GIOGALI SP JEL	CR/TR	BR CR	E27 1x77W		DIM1	22,0	0,36	⊥ IP20	CE CB EAC ENEC PS	2.065,00
GIOGALI SP JEL	BC CR/AG CR/AM CR/BR CR/FU CR/NN CR/OR CR/RA NE	BR CR	E27 1x77W		DIM1	22,0	0,36	⊥ IP20	CE CB EAC ENEC PS	2.965,00
GIOGALI SP OV1	CR/TR	BR CR	E27 4x77W		DIM1	27,0	0,48	⊥ IP20	CE CB EAC ENEC PS	3.010,00
GIOGALI SP OV1	BC CR/AG CR/AM CR/BR CR/FU CR/NN CR/OR CR/RA NE	BR CR	E27 4x77W		DIM1	27,0	0,48	⊥ IP20	CE CB EAC ENEC PS	3.995,00

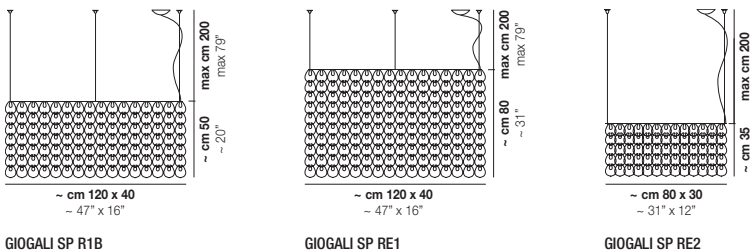

codice / code	vetro / glass	struttura / frame	W	°K option	dimmer option	Δm	m ³	EU cert.	International cert.	€
GIOGALI SP R1B	CR/TR	BR CR	E27 10x77W		DIM1	32,0	0,48	⊥ IP20	CE EAC ENEC PS	3.235,00
GIOGALI SP R1B	BC CR/AG CR/AM CR/BR CR/FU CR/NN CR/OR CR/RA NE	BR CR	E27 10x77W		DIM1	32,0	0,48	⊥ IP20	CE EAC ENEC PS	4.345,00
GIOGALI SP RE1	CR/TR	BR CR	E27 10x77W		DIM1	48,0	0,57	⊥ IP20	CE CB EAC ENEC PS	4.500,00
GIOGALI SP RE1	BC CR/AG CR/AM CR/BR CR/FU CR/NN CR/OR CR/RA NE	BR CR	E27 10x77W		DIM1	48,0	0,57	⊥ IP20	CE CB EAC ENEC PS	6.345,00

codice / code	vetro / glass	struttura / frame	W	°K option	dimmer option	h (m)	m ³	EU cert.	International cert.	€
GIOGALISPRE2	CR/TR	BR CR	E27 3×77W		DIM1	17,0	0,18	⊥ IP20	CE CB ENEC PS	1.755,00
GIOGALISPRE2	BC CRI/AG CRI/AM CR/BR CR/FU CR/INN CR/OR CRI/RA NE	BR CR	E27 3×77W		DIM1	17,0	0,18	⊥ IP20	CE CB ENEC PS	2.395,00

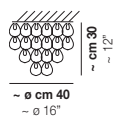

GIOGALI PL 40

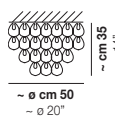

GIOGALI PL 50

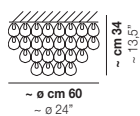

GIOGALI PL 60

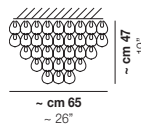

GIOGALI PL 65Q

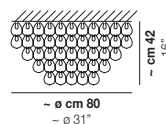

GIOGALI PL 80

codice / code	vetro / glass	struttura / frame	W	°K option	dimmer option	h (m)	m ³	EU cert.	International cert.	€
GIOGALIPL40*	CR/TR	BR CR	E14 2×60W		DIM1	7,0	0,10	⊥ IP20	CE ENEC PS	735,00
GIOGALIPL40*	BC CRI/AG CRI/AM CR/BR CR/FU CR/INN CR/OR CRI/RA NE	BR CR	E14 2×60W		DIM1	7,0	0,10	⊥ IP20	CE ENEC PS	990,00
GIOGALIPL50	CR/TR	BR CR	E27 4×77W		DIM1	15,0	0,20	⊥ IP20	CE CB ENEC PS	1.260,00
GIOGALIPL50	BC CRI/AG CRI/AM CR/BR CR/FU CR/INN CR/OR CRI/RA NE	BR CR	E27 4×77W		DIM1	15,0	0,20	⊥ IP20	CE CB ENEC PS	1.770,00
GIOGALIPL60*	CR/TR	BR CR	E27 4×77W		DIM1	20,0	0,36	⊥ IP20	CE CB ENEC PS	1.655,00
GIOGALIPL60*	BC CRI/AG CRI/AM CR/BR CR/FU CR/INN CR/OR CRI/RA NE	BR CR	E27 4×77W		DIM1	20,0	0,36	⊥ IP20	CE CB ENEC PS	2.240,00
GIOGALIPL65Q	CR/TR	BR CR	E27 4×77W		DIM1	26,0	0,43	⊥ IP20	CE CB ENEC PS	2.295,00
GIOGALIPL65Q	BC CRI/AG CRI/AM CR/BR CR/FU CR/INN CR/OR CRI/RA NE	BR CR	E27 4×77W		DIM1	26,0	0,43	⊥ IP20	CE CB ENEC PS	3.305,00
GIOGALIPL80*	CR/TR	BR CR	E27 5×77W		DIM1	30,0	0,43	⊥ IP20	CE CB ENEC PS	2.345,00
GIOGALIPL80*	BC CRI/AG CRI/AM CR/BR CR/FU CR/INN CR/OR CRI/RA NE	BR CR	E27 5×77W		DIM1	30,0	0,43	⊥ IP20	CE CB ENEC PS	3.240,00

* **Attenzione modello modificato / Attention, model modified**

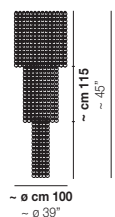

GIOGALI PL CA1

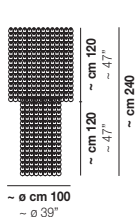

GIOGALI PL CA2

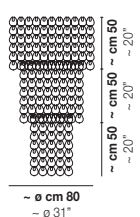

GIOGALI PL CA3

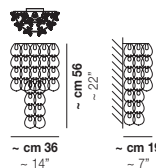

GIOGALI AP

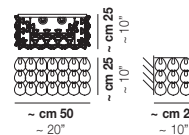

GIOGALI AP 2

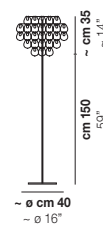

GIOGALI PT

codice / code	vetro / glass	struttura / frame	W	°K option	dimmer option	h (m)	m ³	EU cert.	International cert.	€
GIOGALIPLCA1	CR/TR	BR CR	E27 10×77W		DIM1	117	1,45	⊥ IP20	CE ENEC PS	10.320,00
GIOGALIPLCA1	BC CRI/AG CRI/AM CR/BR CR/FU CR/INN CR/OR CRI/RA NE	BR CR	E27 10×77W		DIM1	117	1,45	⊥ IP20	CE ENEC PS	15.040,00
GIOGALIPLCA2	CR/TR	BR CR	E27 10×77W		DIM1	101	1,34	⊥ IP20	CE CB ENEC PS	8.850,00
GIOGALIPLCA2	BC CRI/AG CRI/AM CR/BR CR/FU CR/INN CR/OR CRI/RA NE	BR CR	E27 10×77W		DIM1	101	1,34	⊥ IP20	CE CB ENEC PS	12.825,00
GIOGALIPLCA3	CR/TR	BR CR	E27 7×77W		DIM1	60,0	0,96	⊥ IP20	CE CB ENEC PS	5.705,00
GIOGALIPLCA3	BC CRI/AG CRI/AM CR/BR CR/FU CR/INN CR/OR CRI/RA NE	BR CR	E27 7×77W		DIM1	60,0	0,96	⊥ IP20	CE CB ENEC PS	7.940,00
GIOGALIAP	CR/TR	BR CR	E14 1×60W		DIM1	6,0	0,11	⊥ IP20	CE ENEC PS	555,00
GIOGALIAP	BC CRI/AG CRI/AM CR/BR CR/FU CR/INN CR/OR CRI/RA NE	BR CR	E14 1×60W		DIM1	6,0	0,11	⊥ IP20	CE ENEC PS	735,00
GIOGALIAP2	CR/TR	BR CR	E27 2×77W		DIM1	8,0	0,11	⊥ IP20	CE CB ENEC PS	770,00
GIOGALIAP2	BC CRI/AG CRI/AM CR/BR CR/FU CR/INN CR/OR CRI/RA NE	BR CR	E27 2×77W		DIM1	8,0	0,11	⊥ IP20	CE CB ENEC PS	990,00
GIOGALIPT**	CR/TR	BR CR	E27 1×77W		ON/OFF*	20,0	0,64	⊥ IP20	CE ENEC PS	1.400,00
GIOGALIPT**	BC CRI/AG CRI/AM CR/BR CR/FU CR/INN CR/OR CRI/RA NE	BR CR	E27 1×77W		ON/OFF*	20,0	0,64	⊥ IP20	CE ENEC PS	1.785,00

** **Attenzione modello modificato / Attention, model modified**

* Vedi nota pagina 8 / See note on page 8

finitura vetro / glass finish | finitura struttura / frame finish

MINIGIOGALI

design Angelo Mangiarotti 1967

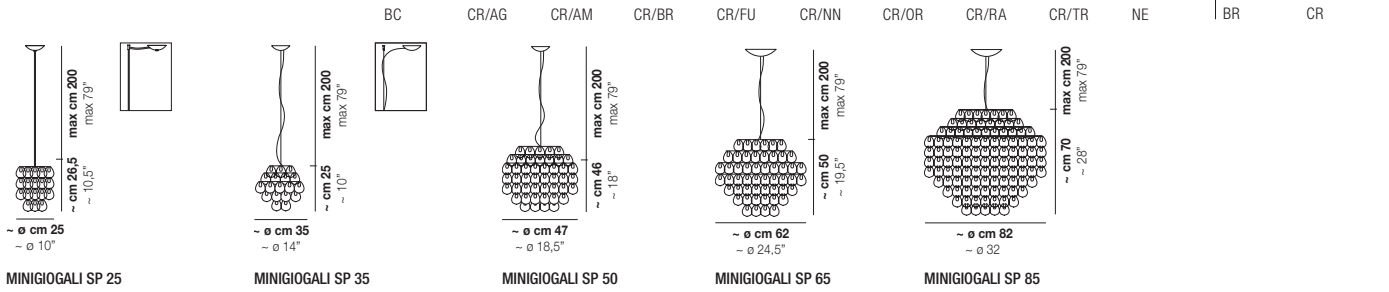
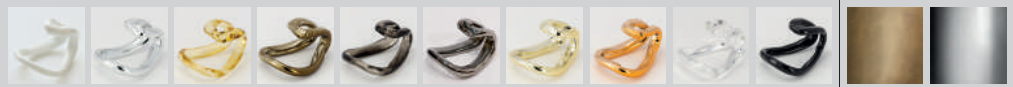

codice / code	vetro / glass	struttura / frame	W	°K option	dimmer option	Δ	m ³	EU cert.	International cert.	€
MINIGIOGALI SP 25	CR/TR	BR CR	G9 1x60W		DIM1	3,0	0,05	IP20	CE EAC	375,00
MINIGIOGALI SP 25	BC CR/AG CR/AM CR/BR CR/FU CR/NN CR/OR CR/RA NE	BR CR	G9 1x60W		DIM1	3,0	0,05	IP20	CE EAC	530,00
MINIGIOGALI SP 35*	CR/TR	BR CR	E27 1x77W		DIM1	5,0	0,16	IP20	CE EAC CB ENEC PS	680,00
MINIGIOGALI SP 35*	BC CR/AG CR/AM CR/BR CR/FU CR/NN CR/OR CR/RA NE	BR CR	E27 1x77W		DIM1	5,0	0,16	IP20	CE EAC CB ENEC PS	950,00
MINIGIOGALI SP 50*	CR/TR	BR CR	E27 3x77W		DIM1	12,0	0,27	IP20	CE EAC CB ENEC PS	1.415,00
MINIGIOGALI SP 50*	BC CR/AG CR/AM CR/BR CR/FU CR/NN CR/OR CR/RA NE	BR CR	E27 3x77W		DIM1	12,0	0,27	IP20	CE EAC CB ENEC PS	2.070,00
MINIGIOGALI SP 65*	CR/TR	BR CR	E27 4x77W		DIM1	18,0	0,41	IP20	CE EAC CB ENEC PS	2.360,00
MINIGIOGALI SP 65*	BC CR/AG CR/AM CR/BR CR/FU CR/NN CR/OR CR/RA NE	BR CR	E27 4x77W		DIM1	18,0	0,41	IP20	CE EAC CB ENEC PS	3.390,00
MINIGIOGALI SP 85*	CR/TR	BR CR	E27 5x77W		DIM1	30,0	0,84	IP20	CE EAC CB ENEC PS	3.805,00
MINIGIOGALI SP 85*	BC CR/AG CR/AM CR/BR CR/FU CR/NN CR/OR CR/RA NE	BR CR	E27 5x77W		DIM1	30,0	0,84	IP20	CE EAC CB ENEC PS	5.535,00

* **Attenzione modello modificato. Kit rosone e catena disponibile su richiesta € 238,00 / Attention, model modified. Canopy and chain kit is available on request € 238,00**

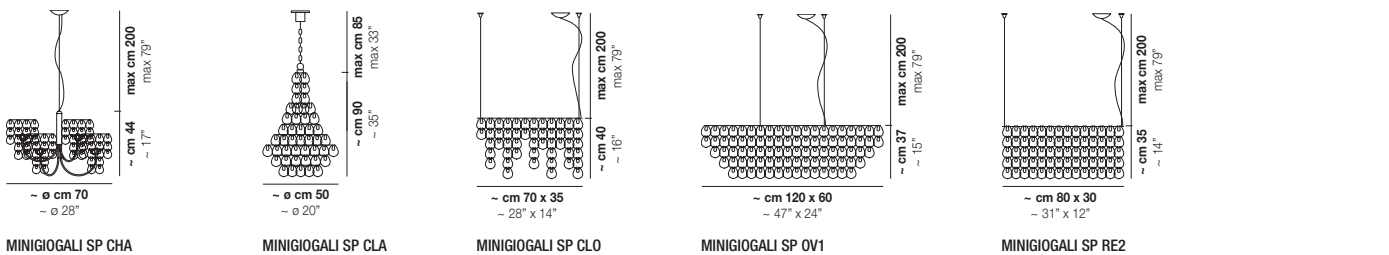

codice / code	vetro / glass	struttura / frame	W	°K option	dimmer option	Δ	m ³	EU cert.	International cert.	€
MINIGIOGALI SP CHA	CR/TR	BR CR	G9 6x60W		DIM1	17,0	0,66	IP20	CE EAC	2.420,00
MINIGIOGALI SP CHA	BC CR/AG CR/AM CR/BR CR/FU CR/NN CR/OR CR/RA NE	BR CR	G9 6x60W		DIM1	17,0	0,66	IP20	CE EAC	3.465,00
MINIGIOGALI SP CLA	CR/TR	BR CR	E27 3x77W		DIM1	17,0	0,68	IP20	CE EAC CB ENEC PS	2.270,00
MINIGIOGALI SP CLA	BC CR/AG CR/AM CR/BR CR/FU CR/NN CR/OR CR/RA NE	BR CR	E27 3x77W		DIM1	17,0	0,68	IP20	CE EAC CB ENEC PS	3.220,00
F MINIGIOGALI SP CLO	CR/TR	BR CR	G9 3x60W		DIM1	13,0	0,25	IP20	CE EAC	2.440,00
F MINIGIOGALI SP CLO	BC CR/AG CR/AM CR/BR CR/FU CR/NN CR/OR CR/RA NE	BR CR	G9 3x60W		DIM1	13,0	0,25	IP20	CE EAC	3.385,00
MINIGIOGALI SP OV1	CR/TR	BR CR	E27 4x77W		DIM1	22,0	0,66	IP20	CE EAC CB ENEC PS	3.735,00
MINIGIOGALI SP OV1	BC CR/AG CR/AM CR/BR CR/FU CR/NN CR/OR CR/RA NE	BR CR	E27 4x77W		DIM1	22,0	0,66	IP20	CE EAC CB ENEC PS	5.265,00
MINIGIOGALI SP RE2	CR/TR	BR CR	E27 3x77W		DIM1	11,0	0,23	IP20	CE EAC CB ENEC PS	1.910,00
MINIGIOGALI SP RE2	BC CR/AG CR/AM CR/BR CR/FU CR/NN CR/OR CR/RA NE	BR CR	E27 3x77W		DIM1	11,0	0,23	IP20	CE EAC CB ENEC PS	2.665,00

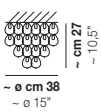

MINIGOGALI PL 40

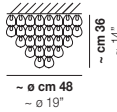

MINIGOGALI PL 50

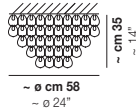

MINIGOGALI PL 60

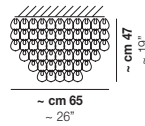

MINIGOGALI PL 65Q

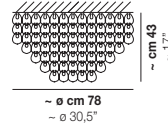

MINIGOGALI PL 80

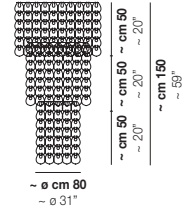

MINIGOGALI PL CA3

codice / code	vetro / glass	struttura / frame	W	°K option	dimmer option	h (m)	m ³	EU cert.	International cert.	€
MINIGOGALI PL 40*	CR/TR	BR CR	E14 2x60W		DIM1	5,0	0,16	⊥ IP20	CE EAC	750,00
MINIGOGALI PL 40*	BC CR/AG CR/AM CR/BR CR/FU CR/NN CR/OR CR/RA NE	BR CR	E14 2x60W		DIM1	5,0	0,16	⊥ IP20	CE EAC	1.035,00
MINIGOGALI PL 50	CR/TR	BR CR	E27 4x77W		DIM1	10,0	0,20	⊥ IP20	CE CB EAC	1.375,00
MINIGOGALI PL 50	BC CR/AG CR/AM CR/BR CR/FU CR/NN CR/OR CR/RA NE	BR CR	E27 4x77W		DIM1	10,0	0,20	⊥ IP20	CE CB EAC	2.005,00
MINIGOGALI PL 60*	CR/TR	BR CR	E27 4x77W		DIM1	20,0	0,38	⊥ IP20	CE CB EAC	1.990,00
MINIGOGALI PL 60*	BC CR/AG CR/AM CR/BR CR/FU CR/NN CR/OR CR/RA NE	BR CR	E27 4x77W		DIM1	20,0	0,38	⊥ IP20	CE CB EAC	2.845,00
MINIGOGALI PL 65Q	CR/TR	BR CR	E27 4x77W		DIM1	18,0	0,50	⊥ IP20	CE CB EAC	2.605,00
MINIGOGALI PL 65Q	BC CR/AG CR/AM CR/BR CR/FU CR/NN CR/OR CR/RA NE	BR CR	E27 4x77W		DIM1	18,0	0,50	⊥ IP20	CE CB EAC	3.895,00
MINIGOGALI PL 80*	CR/TR	BR CR	E27 5x77W		DIM1	25,0	0,54	⊥ IP20	CE CB EAC	2.865,00
MINIGOGALI PL 80*	BC CR/AG CR/AM CR/BR CR/FU CR/NN CR/OR CR/RA NE	BR CR	E27 5x77W		DIM1	25,0	0,54	⊥ IP20	CE CB EAC	4.165,00
MINIGOGALI PL CA3	CR/TR	BR CR	E27 7x77W		DIM1	42,0	1,24	⊥ IP20	CE CB EAC	6.175,00
MINIGOGALI PL CA3	BC CR/AG CR/AM CR/BR CR/FU CR/NN CR/OR CR/RA NE	BR CR	E27 7x77W		DIM1	42,0	1,24	⊥ IP20	CE CB EAC	8.900,00

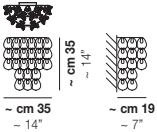
* Attenzione modello modificato / Attention, model modified

MINIGOGALI AP

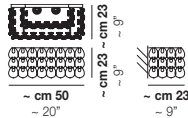

MINIGOGALI AP 2

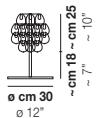

MINIGOGALI LT

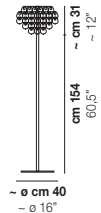

MINIGOGALI PT

codice / code	vetro / glass	struttura / frame	W	°K option	dimmer option	h (m)	m ³	EU cert.	International cert.	€
MINIGOGALI AP	CR/TR	BR CR	E14 1x60W		DIM1	4,0	0,11	⊥ IP20	CE EAC	525,00
MINIGOGALI AP	BC CR/AG CR/AM CR/BR CR/FU CR/NN CR/OR CR/RA NE	BR CR	E14 1x60W		DIM1	4,0	0,11	⊥ IP20	CE EAC	710,00
MINIGOGALI AP 2	CR/TR	BR CR	E27 2x77W		DIM1	7,0	0,11	⊥ IP20	CE CB EAC	890,00
MINIGOGALI AP 2	BC CR/AG CR/AM CR/BR CR/FU CR/NN CR/OR CR/RA NE	BR CR	E27 2x77W		DIM1	7,0	0,11	⊥ IP20	CE CB EAC	1.210,00
MINIGOGALI LT	CR/TR	BR CR	E27 1x77W		ON/OFF	6,0	0,13	⊥ IP20	CE EAC	650,00
MINIGOGALI LT	BC CR/AG CR/AM CR/BR CR/FU CR/NN CR/OR CR/RA NE	BR CR	E27 1x77W		ON/OFF	6,0	0,13	⊥ IP20	CE EAC	845,00
MINIGOGALI PT**	CR/TR	BR CR	E27 1x77W		ON/OFF*	18,0	0,72	⊥ IP20	CE EAC	1.195,00
MINIGOGALI PT**	BC CR/AG CR/AM CR/BR CR/FU CR/NN CR/OR CR/RA NE	BR CR	E27 1x77W		ON/OFF*	18,0	0,72	⊥ IP20	CE EAC	1.545,00

** Attenzione modello modificato / Attention, model modified

* Vedi nota pagina 8 / See note on page 8

finitura vetro / glass finish | finitura struttura / frame finish

GIOGALI3D

design Angelo Mangiarotti 2005



CR/TR

CR

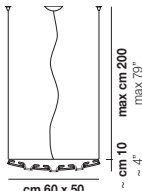
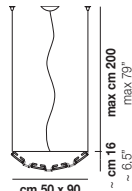
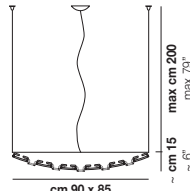
cm 60 x 50
24" x 20"**GIOGALI3D SP 50**cm 50 x 90
20" x 35"**GIOGALI3D SP 90**cm 90 x 85
35" x 33"**GIOGALI3D SP 100**

codice / code	vetro / glass	struttura / frame	W	lumen @3000K	°K option	dimmer option	Ⓜ	m³	EU cert.	International cert.	€	
F GIOGALI3D SP 50	CR/TR	CR	G9	4x60W		DIM1	7,0	0,18	⚡ IP20	CE	ERL	840,00
F GIOGALI3D SP 90	CR/TR	CR	G9	4x60W		DIM1	10,0	0,15	⚡ IP20	CE	ERL	1.170,00
F GIOGALI3D SP 100	CR/TR	CR	G9	4x60W		DIM1	14,0	0,23	⚡ IP20	CE	ERL	1.720,00

finitura vetro / glass finish | finitura struttura / frame finish

GLORIA

design Vistosi 2002



SE/OR

OR

o cm 40
o 16"**GLORIA PT**

codice / code	vetro / glass	struttura / frame	W	lumen @3000K	°K option	dimmer option	Ⓜ	m³	EU cert.	International cert.	€	
F GLORIA PT	SE/OR	OR	E27	1x77W		ON/OFF	17,7	0,39	⚡ IP20	CE	ERL	1.665,00

finitura vetro / glass finish | finitura struttura / frame finish

GOCCIA

design Vistosi 2002



BC/CR

BC

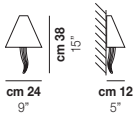
cm 24
9" cm 12
5"**GOCCIA AP**

codice / code	vetro / glass	struttura / frame	W	lumen @3000K	°K option	dimmer option	Ⓜ	m³	EU cert.	International cert.	€	
F GOCCIA AP	BC/CR	BC	E27	1x77W		DIM1	1,0	0,05	⚡ IP20	CE	ERL	360,00

finitura vetro / glass finish

GOTO

design Vistosi 2002



BC

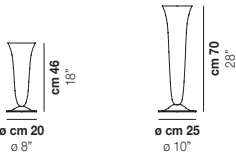

GOTO LT P

GOTO LT G

codice / code	vetro / glass	struttura / frame	W	lumen @3000K	°K option	dimmer option	⚠️	m³	EU cert.	International cert.	€
F GOTO LT P	BC		E27	1×77W		ON/OFF	2,0	0,11	IP20	CE EAC	410,00
F GOTO LT G	BC		E27	1×77W		ON/OFF	5,0	0,11	IP20	CE EAC	605,00

finitura vetro / glass finish

finitura struttura / frame finish

IMPLODE

design Gregorio Spini 2011



BC/CR

BC

BO

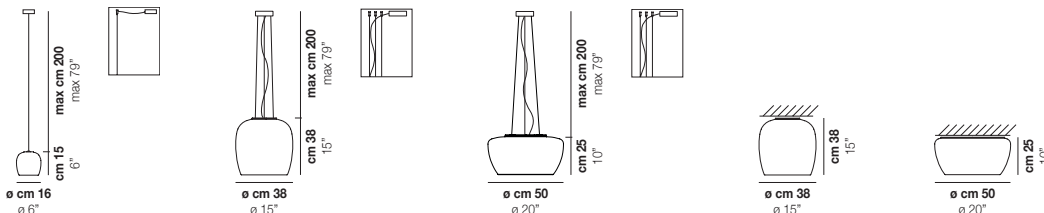

IMPLODE SP 16

IMPLODE SP 38

IMPLODE SP 50

IMPLODE PL 38

IMPLODE PL 50

codice / code	vetro / glass	struttura / frame	W	lumen @3000K	°K option	dimmer option	⚠️	m³	EU cert.	International cert.	€
IMPLODE SP 16*	BC/CR	BC	G9	1×60W		DIM1	2,0	0,04	IP20	CE CB certificate EAC	415,00
IMPLODE SP 16	BC/CR	BC	LED B 9W	1200	2700 3000	DIM2 DIM3	2,0	0,04	IP20	CE EAC	565,00
F IMPLODE SP 38	BC/CR	BC	E27	3×77W		DIM1	13,0	0,19	IP20	CE CB certificate EAC	960,00
IMPLODE SP 50	BC/CR	BC	E27	3×77W		DIM1	16,0	0,21	IP20	CE CB certificate EAC	1.070,00
IMPLODE SP 50	BC/CR	BO	LED O 26W	3700	2700 3000	DIM2 DIM3	16,0	0,21	IP20	CE EAC	1.280,00
F IMPLODE PL 38	BC/CR	BC	E27	3×77W		DIM1	11,0	0,17	IP20	CE CB certificate EAC	755,00
IMPLODE PL 50	BC/CR	BC	E27	3×77W		DIM1	12,0	0,21	IP20	CE CB certificate EAC	915,00
IMPLODE PL 50	BC/CR	BO	LED O 26W	3700	2700 3000	DIM2 DIM3	12,0	0,21	IP20	CE EAC	1.115,00

* **Attenzione, modello modificato:** ora fornito con rosone metallico / **Attention, model modified:** now supplied with metal canopy

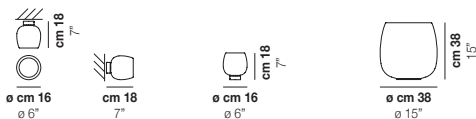

IMPLODE FA 16

IMPLODE LT 16

IMPLODE LT 38

codice / code	vetro / glass	struttura / frame	W	lumen @3000K	°K option	dimmer option	⚠️	m³	EU cert.	International cert.	€
F IMPLODE FA 16	BC/CR	BC	G9	1×60W		DIM1	2,5	0,04	IP20	CE CB certificate EAC	350,00
F IMPLODE LT 16	BC/CR	BC	G9	1×60W		ON/OFF	2,5	0,04	IP20	CE EAC	405,00
F IMPLODE LT 38	BC/CR	BC	E27	3×77W		ON/OFF	13,0	0,19	IP20	CE CB certificate EAC	915,00

New

INCANTO

design Pio e Tito Toso 2019

finitura vetro / glass finish

finitura struttura / frame finish

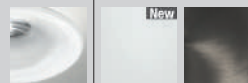

BC/SF

BO

NNS

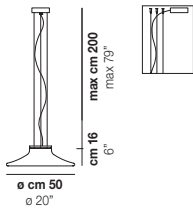

INCANTO SP

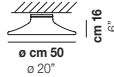

INCANTO PL

codice / code	vetro / glass	struttura / frame	W	lumen @3000K	°K option	dimmer option		Ⓜ	m ³	EU cert.	International cert.	€			
INCANTOSP	BC/SF	BO NNS	LED 03	12W	1600	2700	3000	DIM2	DIM3	5,0	0,13	IP20	CE	ERC	780,00
INCANTOPL	BC/SF	BO NNS	LED 03	12W	1600	2700	3000	DIM2	DIM3	5,0	0,13	IP20	CE	ERC	680,00

finitura vetro / glass finish

finitura struttura / frame finish

INFINITA

design Renato Toso, Noti Massari & Associati 2009



BC/ST

BC

BO

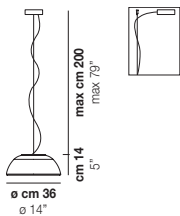

INFINITA SP 36

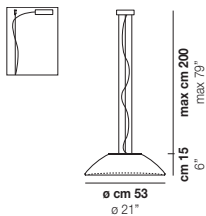

INFINITA SP 53

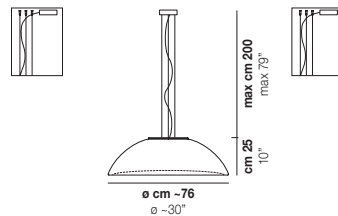

INFINITA SP 80

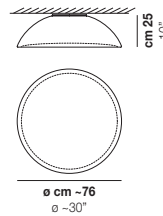

INFINITA PL 80

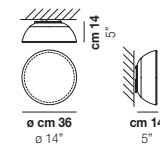

INFINITA PP 36

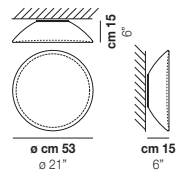

INFINITA PP 53

codice / code	vetro / glass	struttura / frame	W	lumen @3000K	°K option	dimmer option		Ⓜ	m ³	EU cert.	International cert.	€			
INFINITASP36	BC/ST	BC	E27	1×77W		DIM1		3,5	0,07	IP20	CE CB	ERC	395,00		
INFINITASP36	BC/ST	BO	LED F	12W	1700	2700	3000	DIM2	DIM3	3,5	0,07	IP20	CE	ERC	545,00
INFINITASP53	BC/ST	BC	E27	2×77W		DIM1		7,0	0,16	IP20	CE CB	ERC	565,00		
INFINITASP53	BC/ST	BO	LED G	19W	2850	2700	3000	DIM2	DIM3	7,0	0,16	IP20	CE	ERC	735,00
INFINITASP80	BC/ST	BC	E27	5×77W		DIM1		18,0	0,47	IP20	CE CB	ERC	1.805,00		
INFINITASP80	BC/ST	BO	LED O	26W	3700	2700	3000	DIM2	DIM3	18,0	0,47	IP20	CE	ERC	2.015,00
INFINITAPL80	BC/ST	BC	E27	5×77W		DIM1		18,0	0,47	IP20	CE CB	ERC	1.585,00		
INFINITAPL80	BC/ST	BO	LED O	26W	3700	2700	3000	DIM2	DIM3	18,0	0,47	IP20	CE	ERC	1.785,00
INFINITAPP36	BC/ST	BC	E27	1×77W		DIM1		3,0	0,05	IP20	CE CB	ERC	290,00		
INFINITAPP36	BC/ST	BO	LED F	12W	1700	2700	3000	DIM2	DIM3	3,0	0,05	IP20	CE	ERC	430,00
INFINITAPP53	BC/ST	BC	E27	2×77W		DIM1		6,0	0,13	IP20	CE CB	ERC	400,00		
INFINITAPP53	BC/ST	BO	LED G	19W	2850	2700	3000	DIM2	DIM3	6,0	0,13	IP20	CE	ERC	560,00

finitura vetro / glass finish | finitura struttura / frame finish

JO

design Pio e Tito Toso 2011

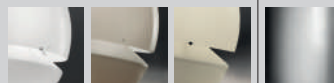

BC/DI | FU/DI | SB/DI | CR

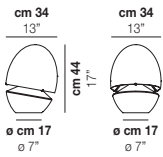

JO LT

codice / code	vetro / glass	struttura / frame	W	lumen @3000K	°K option	dimmer option	⚡	m³	EU cert.	International cert.	€
F JOLT	BC/DI FU/DI SB/DI	CR	E27	1x77W		ON/OFF	⚡	4,2 0,15	IP20	CE CB certificate ENEC CCC	515,00

finitura vetro / glass finish | finitura struttura / frame finish

JUBE

design Favaretto&Partners 2017



AA/BC | AA/TR | CR/BC | CR/TR | FU/BC | FU/TR | TB/BC | TB/TR | VA/BC | VA/TR | AVS | OS

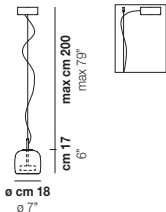

JUBE SP S

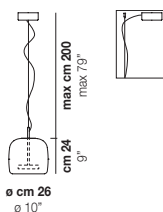

JUBE SP 1 P

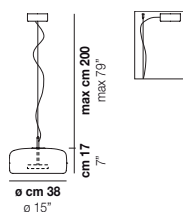

JUBE SP 1 G

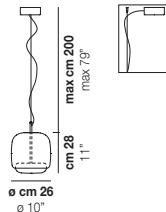

JUBE SP P

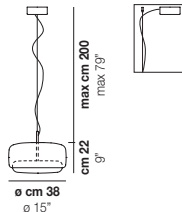

JUBE SP G

codice / code	vetro / glass	struttura / frame	W	lumen @3000K	°K option	dimmer option	⚡	m³	EU cert.	International cert.	€
New JUBESPS	AA/TR VA/TR CR/TR FU/TR TB/TR	AVS OS	LED 14	8,5W	1200	2700 3000	DIM2 DIM3	2,0 0,07	IP20	CE ENEC PS	565,00
JUBESP1P	AA/TR VA/TR CR/TR FU/TR TB/TR	AVS OS	LED 02	13W	2000	2700 3000	DIM2 DIM3	2,0 0,10	IP20	CE ENEC PS	705,00
JUBESP1G	AA/TR CR/TR FU/TR TB/TR VA/TR	AVS OS	LED 02	13W	2000	2700 3000	DIM2 DIM3	4,5 0,14	IP20	CE ENEC PS	850,00
JUBESPP	AA/BC CR/BC FU/BC TB/BC VA/BC	AVS OS	LED 02	13W	2000	2700 3000	DIM2 DIM3	2,0 0,10	IP20	CE ENEC PS	835,00
JUBESPG	AA/BC CR/BC FU/BC TB/BC VA/BC	AVS OS	LED 02	13W	2000	2700 3000	DIM2 DIM3	6,0 0,14	IP20	CE ENEC PS	985,00

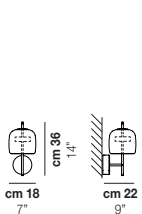

JUBE AP S

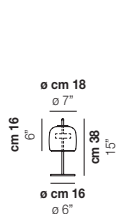

JUBE LT S

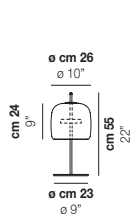

JUBE LT P

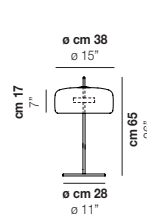

JUBE LT G

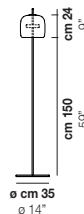

JUBE PT P

codice / code	vetro / glass	struttura / frame	W	lumen @3000K	°K option	dimmer option	⚡	m³	EU cert.	International cert.	€
New JUBEAPS	AA/TR CR/TR FU/TR TB/TR VA/TR	AVS OS	LED 14	8,5W	1200	2700 3000	DIM2 DIM3	2,0 0,08	IP20	CE ENEC PS	580,00
JUBELTS	AA/TR CR/TR FU/TR TB/TR VA/TR	AVS OS	LED 16	8,5W	1200	2700 3000	DIM4	2,0 0,08	IP20	CE ENEC	665,00
JUBELTP	AA/TR CR/TR FU/TR TB/TR VA/TR	AVS OS	LED 15	13W	2000	2700 3000	DIM4	3,0 0,08	IP20	CE ENEC	870,00
New JUBELTG	AA/TR CR/TR FU/TR TB/TR VA/TR	AVS OS	LED 15	13W	2000	2700 3000	DIM4	6,0 0,12	IP20	CE ENEC	1.055,00
JUBEPTP	AA/TR CR/TR FU/TR TB/TR VA/TR	AVS OS	LED 15	13W	2000	2700 3000	DIM4	9,0 0,08	IP20	CE ENEC	1.335,00

finitura vetro / glass finish

finitura struttura / frame finish

KIRA

design Alberto Saggia e Valerio Sommella 2017



CR/BT

BV

NEO

OT

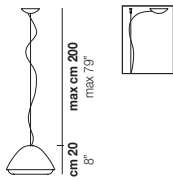

max cm 200
max 79"
cm 20
ø cm 32
ø 12"

KIRA SP P

codice / code	vetro / glass	struttura / frame	W	lumen @3000K	°K option	dimmer option	m³	m³	EU cert.	International cert.	€	
KIRA SPP	CR/BT	BV NEO OT	E27	1x77W		DIM1	3,5	0,08	IP20	CE EAC	495,00	
KIRA SPP	CR/BT	BV NEO OT	NEW LED C	12W	1600	2700 3000	DIM2 DIM3	3,5	0,08	IP20	CE EAC	645,00

finitura vetro / glass finish

finitura struttura / frame finish

LACRIMA

design Paolo Crepx 2003



BC/LU

NI

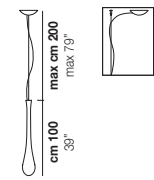

max cm 200
max 79"
cm 100
ø cm 17
ø 7"

LACRIMA SP P

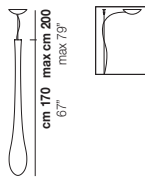

max cm 200
max 79"
cm 170
ø cm 21
ø 8"

LACRIMA SP G

codice / code	vetro / glass	struttura / frame	W	lumen @3000K	°K option	dimmer option	m³	m³	EU cert.	International cert.	€	
LACRIMA SPP	BC/LU	NI	E27	1x77W		DIM1	4,0	0,16	IP20	CE EAC	415,00	
LACRIMA SPP	BC/LU	NI	NEW LED C	12W	1600	2700 3000	DIM2 DIM3	4,0	0,16	IP20	CE EAC	565,00
LACRIMA SPG	BC/LU	NI	E27	1x77W		DIM1	6,5	0,33	IP20	CE EAC	800,00	
LACRIMA SPG	BC/LU	NI	NEW LED C	12W	1600	2700 3000	DIM2 DIM3	6,5	0,33	IP20	CE EAC	950,00

finitura vetro / glass finish

finitura struttura / frame finish

LEPANTO

design Luciano Vistosi 1968



BC/PU

NI

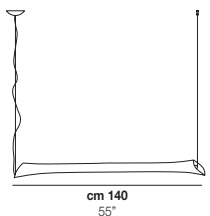

LEPANTO SP

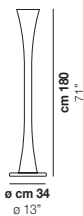

max cm 200
max 79"
cm 180
ø cm 34
ø 13"

LEPANTO SP

codice / code	vetro / glass	struttura / frame	W	lumen @3000K	°K option	dimmer option	m³	m³	EU cert.	International cert.	€
LEPANTO SP	BC/PU	NI	NEW LED G5LED	1x18W		ON/OFF	8,0	0,20	IP20	CE EAC	1.225,00
LEPANTO PT	BC/PU	NI	NEW LED G5+E27	1x18W+1x77W*		ON/OFF DIM4	11,0	0,78	IP20	CE EAC	2.935,00

* Lampada a doppia accensione, DIM4 disponibile su lampadina attacco E27 / Double switch lamp, DIM4 available on E27 bulb

finitura vetro / glass finish | finitura struttura / frame finish



LIO

design Vistosi 1972

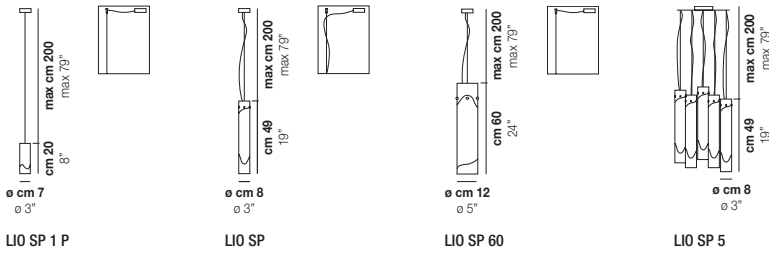

codice / code	vetro / glass	struttura / frame	W	lumen @3000K	°K option	dimmer option	△	m³	EU cert.	International cert.	€
LIO SP 1 P*	CR/BC	NI	G9	1×60W		DIM1	1,0	0,01	IP20	CE CB EAC	240,00
LIO SP 1 P	CR/BC	NI	LED A	9W	1200	2700 3000 DIM2 DIM3	1,0	0,01	IP20	CE EAC	390,00
LIO SP	CR/BC	NI	E27	1×77W		DIM1	1,5	0,05	IP20	CE EAC (P)	395,00
LIO SP	CR/BC	NI	LED C	12W	1600	2700 3000 DIM2 DIM3	5,0	0,08	IP20	CE EAC (P)	545,00
F LIO SP 60	CR/BC	NI	E27	1×77W		DIM1	2,5	0,05	IP20	CE EAC (P)	585,00
F LIO SP 60	CR/BC	NI	LED C	12W	1600	2700 3000 DIM2 DIM3	5,0	0,08	IP20	CE EAC (P)	735,00
LIO SP 5	CR/BC	NI	E27	5×77W		DIM1	8,0	0,13	IP20	CE EAC (P)	1.960,00

* **Attenzione, modello modificato:** ora fornito con rosone metallico / **Attention, model modified:** now supplied with metal canopy

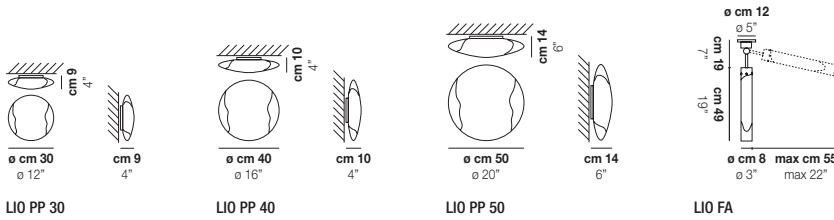

codice / code	vetro / glass	struttura / frame	W	lumen @3000K	°K option	dimmer option	△	m³	EU cert.	International cert.	€
LIO PP 30	CR/BC	BC	E27	1×77W		DIM1	2,0	0,05	IP20	CE CB EAC (P)	255,00
LIO PP 30	CR/BC	BO	LED F	12W	1700	2700 3000 DIM2 DIM3	2,0	0,05	IP20	CE EAC (P)	395,00
LIO PP 40	CR/BC	BC	E27	1×77W		DIM1	2,5	0,07	IP20	CE CB EAC (P)	350,00
LIO PP 40	CR/BC	BO	LED F	12W	1700	2700 3000 DIM2 DIM3	2,5	0,07	IP20	CE EAC (P)	490,00
LIO PP 50	CR/BC	BC	E27	2×77W		DIM1	4,0	0,13	IP20	CE CB EAC (P)	495,00
LIO PP 50	CR/BC	BO	LED G	19W	2850	2700 3000 DIM2 DIM3	4,0	0,05	IP20	CE EAC (P)	655,00
F LIO FA	CR/BC	NI	E27	1×77W		DIM1	2,0	0,05	IP20	CE CB EAC (P)	415,00

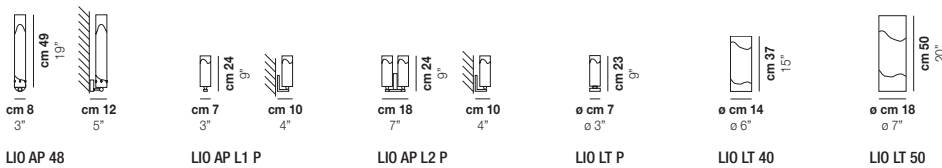

codice / code	vetro / glass	struttura / frame	W	lumen @3000K	°K option	dimmer option	△	m³	EU cert.	International cert.	€
LIO AP 48	CR/BC	NI	E27	1×77W		DIM1	2,0	0,05	IP20	CE EAC (P)	405,00
LIO AP L1 P	CR/BC	NI	G9	1×60W		DIM1	2,0	0,01	IP20	CE EAC (P)	380,00

codice / code	vetro / glass	struttura / frame	W	lumen @3000K	°K option	dimmer option	RA	m³	EU cert.	International cert.	€
LIAPL2P	CR/BC	NI	G9	2×60W		DIM1	2,0	0,03	IP20	CE EAC CB CCC	540,00
LIOLT P	CR/BC	NI	G9	1×60W		ON/OFF	2,0	0,02	IP20	CE EAC	320,00
LIOLT 40	CR/BC		E27	1×77W		ON/OFF	2,5	0,05	IP20	CE EAC CB CCC PS	425,00
LIOLT 50	CR/BC		E27	1×77W		ON/OFF	4,0	0,11	IP20	CE EAC CB CCC PS	530,00

finitura vetro / glass finish | finitura struttura / frame finish

LUCCIOLA

design Vistosi 1981



BC/ST | BC | BO | NI

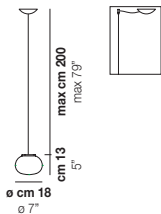

LUCCIOLA SP 18

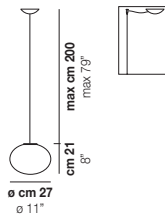

LUCCIOLA SP 27

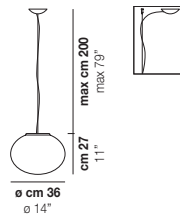

LUCCIOLA SP P

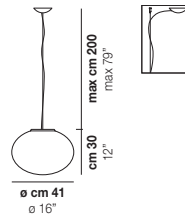

LUCCIOLA SP M

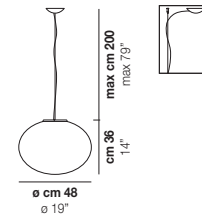

LUCCIOLA SP G

codice / code	vetro / glass	struttura / frame	W	lumen @3000K	°K option	dimmer option	RA	m³	EU cert.	International cert.	€
LUCCIOLA SP 18*	BC/ST	BC	E14	1×46W		DIM1	0,5	0,02	IP20	CE EAC CB CCC	170,00
LUCCIOLA SP 27	BC/ST	BC	E14	1×46W		DIM1	1,5	0,05	IP20	CE EAC CB CCC	210,00
LUCCIOLA SP P	BC/ST	NI	E27	1×77W		DIM1	2,5	0,11	IP20	CE EAC CB CCC	315,00
LUCCIOLA SP P	BC/ST	BO	LED F	12W 1700	2700 3000	DIM2 DIM3	2,5	0,11	IP20	CE EAC CB CCC	465,00
LUCCIOLA SP M	BC/ST	NI	E27	3×77W		DIM1	3,5	0,16	IP20	CE EAC CB CCC	350,00
LUCCIOLA SP M	BC/ST	BO	LED F	12W 1700	2700 3000	DIM2 DIM3	3,5	0,16	IP20	CE EAC CB CCC	495,00
LUCCIOLA SP G	BC/ST	NI	E27	3×77W		DIM1	4,0	0,22	IP20	CE EAC CB CCC	425,00
LUCCIOLA SP G	BC/ST	BO	LED F	12W 1700	2700 3000	DIM2 DIM3	4,0	0,22	IP20	CE EAC CB CCC	575,00

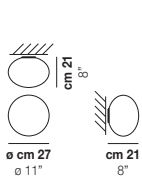
* **Attenzione, modello modificato:** ora fornito con rosone metallico / **Attention, model modified:** now supplied with metal canopy

LUCCIOLA PP 27

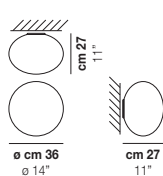

LUCCIOLA PP P

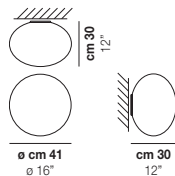

LUCCIOLA PP M

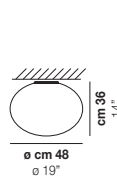

LUCCIOLA PL G

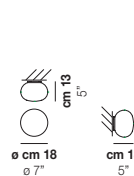

LUCCIOLA FA 18

codice / code	vetro / glass	struttura / frame	W	lumen @3000K	°K option	dimmer option	RA	m³	EU cert.	International cert.	€
LUCCIOLA PP 27	BC/ST	BC	E14	1×48W		DIM1	1,5	0,05	IP20	CE EAC CB CCC	155,00
LUCCIOLA PP P	BC/ST	BC	E27	1×77W		DIM1	2,5	0,11	IP20	CE EAC CB CCC	225,00
LUCCIOLA PP P	BC/ST	BO	LED F	12W 1700	2700 3000	DIM2 DIM3	2,5	0,11	IP20	CE EAC CB CCC	365,00
LUCCIOLA PP M	BC/ST	BC	E27	3×77W		DIM1	3,5	0,16	IP20	CE EAC CB CCC	245,00
LUCCIOLA PP M	BC/ST	BO	LED F	12W 1700	2700 3000	DIM2 DIM3	3,5	0,16	IP20	CE EAC CB CCC	385,00
LUCCIOLA PL G	BC/ST	BC	E27	3×77W		DIM1	4,5	0,22	IP20	CE EAC CB CCC	385,00
LUCCIOLA PL G	BC/ST	BO	LED F	12W 1700	2700 3000	DIM2 DIM3	4,5	0,22	IP20	CE EAC CB CCC	525,00
LUCCIOLA FA 18	BC/ST	BC	E14	1×48W		DIM1	0,5	0,02	IP20	CE EAC	115,00



LUCCIOLA LT 18



LUCCIOLA LT 27

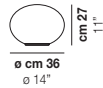

LUCCIOLA LT P

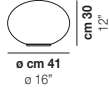

LUCCIOLA LT M

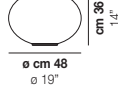

LUCCIOLA LT G

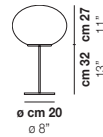

LUCCIOLA LT 30 P

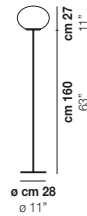

LUCCIOLA PT P

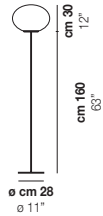

LUCCIOLA PT M

codice / code	vetro / glass	struttura / frame	W	lumen @3000K	°K option	dimmer option	m³	EU cert.	International cert.	€
LUCCIOLALT18	BC/ST	BC	E14	1x48W		ON/OFF	0,5, 0,02	CE	ERL	155,00
LUCCIOLALT27	BC/ST	BC	E14	1x48W		ON/OFF	1,5, 0,05	CE	ERL	175,00
LUCCIOLALTP	BC/ST	NI	E27	1x77W		ON/OFF	3,0, 0,11	CE	ERL	290,00
LUCCIOLALTM	BC/ST	NI	E27	1x77W		ON/OFF	3,5, 0,16	CE	ERL	310,00
LUCCIOLALTG	BC/ST	NI	E27	1x77W		ON/OFF	4,0, 0,22	CE	ERL	410,00
LUCCIOLALT30P	BC/ST	NI	E27	1x77W		ON/OFF	5,5, 0,20	CE	ERL	480,00
LUCCIOLAPTP	BC/ST	NI	E27	1x77W		ON/OFF*	8,0, 0,27	CE	ERL	640,00
LUCCIOLAPTM	BC/ST	NI	E27	1x77W		ON/OFF*	9,0, 0,32	CE	ERL	710,00

* Vedi nota pagina 8 / See note on page 8

New MEDEA
design Oriano Favaretto 2019

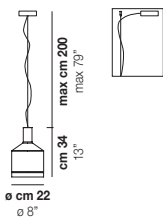

MEDEA SP 1

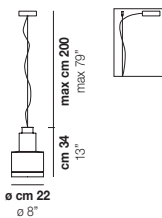

MEDEA SP 2

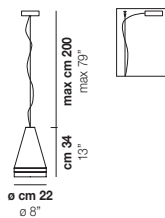

MEDEA SP 3

codice / code	vetro / glass	struttura / frame	W	lumen @3000K	°K option	dimmer option	m³	EU cert.	International cert.	€
MEDEASP1	BC/SF CR/TR	AVS	LED 04	14W	2700 3000	DIM2 DIM3	3,0, 0,10	CE	ERL	725,00
MEDEASP2	BC/SF FU/TR	AVS	LED 04	14W	2700 3000	DIM2 DIM3	3,0, 0,10	CE	ERL	725,00
MEDEASP3	BC/SF VA/TR	AVS	LED 04	14W	2700 3000	DIM2 DIM3	3,0, 0,10	CE	ERL	725,00

MIA
design Vistosi 2013

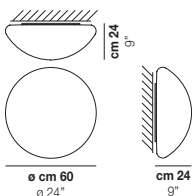
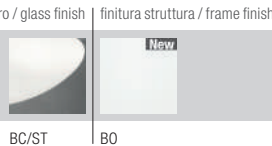

MIA PP 60

codice / code	vetro / glass	struttura / frame	W	lumen @3000K	°K option	dimmer option	m³	EU cert.	International cert.	€
MIAAPP60	BC/ST	BC	E27	3x77W		DIM1	6,5, 0,21	CE	CB ERL	555,00
MIAAPP60	BC/ST	BO	LED 0	26W	2700 3000	DIM2 DIM3	6,5, 0,21	CE	ERL	755,00

finitura vetro / glass finish | finitura struttura / frame finish

MIRAGE

design Giovanni Barbato 2017



BC/AM | BC/CR | BC/FU | BC

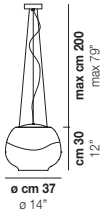

MIRAGE SP

codice / code	vetro / glass	struttura / frame	W	lumen @3000K	°K option	dimmer option		Ⓜ	m ³	EU cert.	International cert.	€		
MIRAGESP	BC/CR	BC	LED 07	19,5W	2850	2700	3000	DIM2	DIM3	5,5	0,13	⚡ IP20	CE ENEC CB ETL PS	830,00
MIRAGESP	BC/AM BC/FU	BC	LED 07	19,5W	2850	2700	3000	DIM2	DIM3	5,5	0,13	⚡ IP20	CE ENEC CB ETL PS	875,00

finitura vetro / glass finish | finitura struttura / frame finish

MORIS

design Vistosi 1998



BC/ST | BC | BO

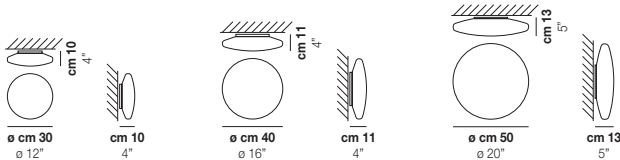

MORIS PP 30

MORIS PP 40

MORIS PP 50

codice / code	vetro / glass	struttura / frame	W	lumen @3000K	°K option	dimmer option		Ⓜ	m ³	EU cert.	International cert.	€		
MORISPP30	BC/ST	BC	E27	1x77W		DIM1		2,0	0,03	⚡ IP20	CE ENEC CB ETL CCC	165,00		
MORISPP30	BC/ST	BO	LED F	12W	1700	2700	3000	DIM2	DIM3	2,0	0,03	⚡ IP20	CE ENEC CB ETL CCC	305,00
MORISPP40	BC/ST	BC	E27	1x77W		DIM1		3,0	0,05	⚡ IP20	CE ENEC CB ETL CCC	240,00		
MORISPP40	BC/ST	BO	LED G	19W	2850	2700	3000	DIM2	DIM3	3,0	0,05	⚡ IP20	CE ENEC CB ETL CCC	400,00
MORISPP50	BC/ST	BC	E27	2x77W		DIM1		6,0	0,13	⚡ IP20	CE ENEC CB ETL CCC	385,00		
MORISPP50	BC/ST	BO	LED G	19W	2850	2700	3000	DIM2	DIM3	6,0	0,13	⚡ IP20	CE ENEC CB ETL CCC	545,00

finitura vetro / glass finish

MUNEGA

design Luciano Vistosi 1978



BC

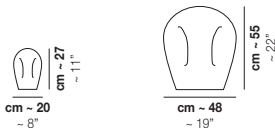

MUNEGA LT P

MUNEGA LT G

codice / code	vetro / glass	struttura / frame	W	lumen @3000K	°K option	dimmer option		Ⓜ	m ³	EU cert.	International cert.	€
MUNEGALTP	BC		E14	1x60W		ON/OFF		3,0	0,05	⚡ IP20	CE ENEC CB ETL CCC	375,00
MUNEGALTG	BC		E27	1x77W		ON/OFF*		5,0	0,23	⚡ IP20	CE ENEC CB ETL CCC	860,00

* Vedi nota pagina 8 / See note on page 8

finitura vetro / glass finish

finitura struttura / frame finish

NARANZA

design Vistosi 1965



BC/LU

CR

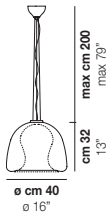

NARANZA SP P

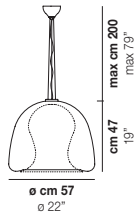

NARANZA SP G

codice / code	vetro / glass	struttura / frame	W	lumen @3000K	°K option	dimmer option	Ⓜ	m ³	EU cert.	International cert.	€
NARANZA SP P	BC/LU	CR	E27	1×77W		DIM1	9,0	0,24	⚡ IP20	CE EAC	1.225,00
NARANZA SP G	BC/LU	CR	E27	1×77W		DIM1	20,0	0,42	⚡ IP20	CE EAC	2.100,00

finitura vetro / glass finish

finitura struttura / frame finish

NAXOS

design Vistosi 1988



BC/ST

BC

NI

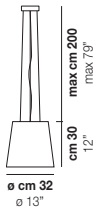

NAXOS SP 50

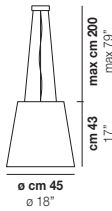

NAXOS SP 76



NAXOS LT MN



NAXOS LT 33

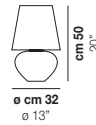

NAXOS LT 50

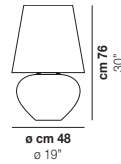

NAXOS LT 76

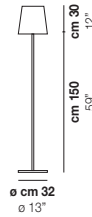

NAXOS PT 50

codice / code	vetro / glass	struttura / frame	W	lumen @3000K	°K option	dimmer option	Ⓜ	m ³	EU cert.	International cert.	€
NAXOS SP 50	BC/ST	NI	E27	3×77W		DIM1	4,0	0,13	⚡ IP20	CE EAC	420,00
NAXOS SP 76	BC/ST	NI	E27	3×77W		DIM1	10,0	0,23	⚡ IP20	CE EAC	975,00
NAXOS LTMN	BC/ST	BC	E14	1×60W		ON/OFF	1,0	0,04	⚡ IP20	CE EAC	310,00
NAXOS LT 33	BC/ST	BC	E14	1×60W + 1×40W		ON/OFF	1,5	0,08	⚡ IP20	CE EAC	330,00
NAXOS LT 50	BC/ST	BC	E27	1×77WE27 + 1×40WE14		ON/OFF	3,5	0,17	⚡ IP20	CE EAC	445,00
NAXOS LT 76	BC/ST	BC	E27	1×77WE27 + 3×40WE14 + 1×46WE27		ON/OFF	10,0	0,42	⚡ IP20	CE EAC	1.105,00
NAXOS PT 50	BC/ST	NI	E27	3×77W		ON/OFF*	10,0	0,26	⚡ IP20	CE EAC	940,00

* Vedi nota pagina 8 / See note on page 8

finitura vetro / glass finish | finitura struttura / frame finish

NEOCHIC

design Chiaramonte & Marin 2013



BC/ST | BC | BO | NIB

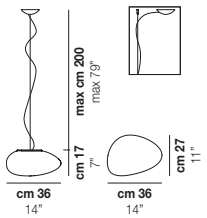

NEOCHIC SP P

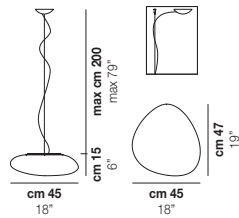

NEOCHIC SP M

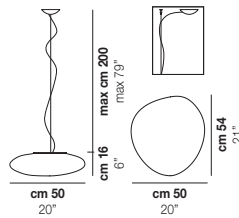

NEOCHIC SP G

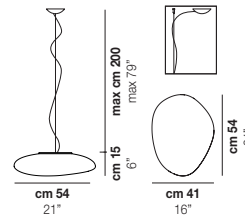

NEOCHIC SP R

codice / code	vetro / glass	struttura / frame	W	lumen @3000K	°K option	dimmer option	RA	m³	EU cert.	International cert.	€	
NEOCHIC SPP	BC/ST	NIB	E27	1x77W		DIM1	4,0	0,07	IP20	CE CB ENEC ETL	315,00	
NEOCHIC SPP	BC/ST	BO	LED F	12W	1700	2700 3000	DIM2 DIM3	4,0	0,07	IP20	CE ENEC ETL	455,00
NEOCHIC SPM	BC/ST	NIB	E27	2x77W		DIM1	4,5	0,13	IP20	CE CB ENEC ETL	475,00	
NEOCHIC SPM	BC/ST	BO	LED G	19W	2850	2700 3000	DIM2 DIM3	4,5	0,13	IP20	CE ENEC ETL	645,00
NEOCHIC SPG	BC/ST	NIB	E27	2x77W		DIM1	5,0	0,13	IP20	CE CB ENEC ETL	550,00	
NEOCHIC SPG	BC/ST	BO	LED G	19W	2850	2700 3000	DIM2 DIM3	5,0	0,13	IP20	CE ENEC ETL	720,00
NEW NEOCHIC SPR	BC/ST	NIB	E27	2x77W		DIM1	5,0	0,13	IP20	CE CB ENEC ETL	575,00	
NEW NEOCHIC SPR	BC/ST	BO	LED G	19W	2850	2700 3000	DIM2 DIM3	5,0	0,13	IP20	CE ENEC ETL	745,00

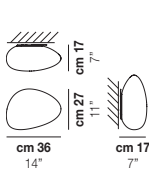

NEOCHIC PP P

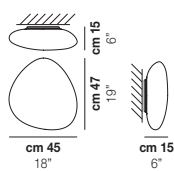

NEOCHIC PP M

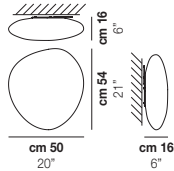

NEOCHIC PP G

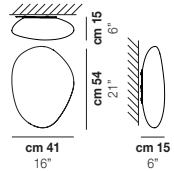

NEOCHIC PP R

codice / code	vetro / glass	struttura / frame	W	lumen @3000K	°K option	dimmer option	RA	m³	EU cert.	International cert.	€	
NEOCHIC PPP	BC/ST	BC	E27	1x77W		DIM1	3,0	0,07	IP20	CE CB ENEC ETL	198,00	
NEOCHIC PPP	BC/ST	BO	LED F	12W	1700	2700 3000	DIM2 DIM3	3,0	0,07	IP20	CE ENEC ETL	318,00
NEOCHIC PPM	BC/ST	BC	E27	2x77W		DIM1	4,0	0,10	IP20	CE CB ENEC ETL	340,00	
NEOCHIC PPM	BC/ST	BO	LED G	19W	2850	2700 3000	DIM2 DIM3	4,0	0,10	IP20	CE ENEC ETL	480,00
NEOCHIC PPG	BC/ST	BC	E27	2x77W		DIM1	4,5	0,13	IP20	CE CB ENEC ETL	445,00	
NEOCHIC PPG	BC/ST	BO	LED G	19W	2850	2700 3000	DIM2 DIM3	4,5	0,13	IP20	CE ENEC ETL	585,00
NEW NEOCHIC PPR	BC/ST	BC	E27	2x77W		DIM1	4,5	0,13	IP20	CE CB ENEC ETL	445,00	
NEW NEOCHIC PPR	BC/ST	BO	LED G	19W	2850	2700 3000	DIM2 DIM3	4,5	0,13	IP20	CE ENEC ETL	585,00

finitura vetro / glass finish

NESSA

design Vistosi 1972



CR/BC

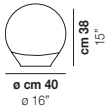

NESSA LT

codice / code	vetro / glass	struttura / frame	W	lumen @3000K	°K option	dimmer option	$\frac{l}{m^3}$	m ³	EU cert.	International cert.	€
NESSALT	CR/BC		E27	1×77W		ON/OFF*	5,0	0,16	IP20	CE EAR CCC PS	690,00

* Vedi nota pagina 8 / See note on page 8

finitura vetro / glass finish

finitura struttura / frame finish

NINFEA

design Oriano Favaretto 2009



AM

BC/LU

CR

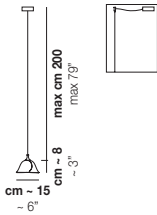

NINFEA SP P

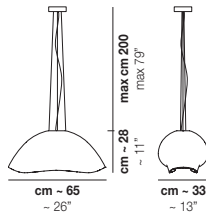

NINFEA SP G

codice / code	vetro / glass	struttura / frame	W	lumen @3000K	°K option	dimmer option	$\frac{l}{m^3}$	m ³	EU cert.	International cert.	€
NINFEASP P	AM BC/LU	CR	G9	1×60W		DIM1	1,0	0,03	IP20	CE CB EAR CCC PS	420,00
NINFEASPG	AM BC/LU	CR	E27	1×77W		DIM1	9,0	0,22	IP20	CE CB EAR CCC	1.285,00

finitura vetro / glass finish

finitura struttura / frame finish

NODO

design Pio e Tito Toso 2015



BC/LU

CR

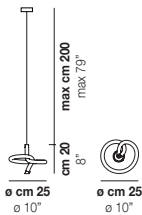

NODO SP 25

codice / code	vetro / glass	struttura / frame	W	lumen @3000K	°K option	dimmer option	$\frac{l}{m^3}$	m ³	EU cert.	International cert.	€
NODOSP25	BC/LU	CR	G9	1×48W		DIM1	2,0	0,04	IP20	CE EAR CCC	300,00

finitura vetro / glass finish | finitura struttura / frame finish

NOVECENTO

design Romani Sacconi Architetti Associati 2013

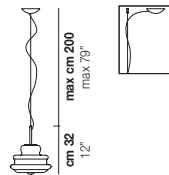

BC/RI | CR/RI | CR

ø cm 27
ø 11"

NOVECENTO SP P

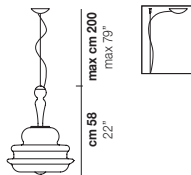
ø cm 44
ø 17"

NOVECENTO SP M

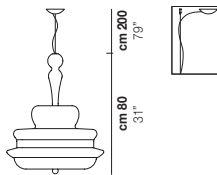
ø cm 64
ø 25"

NOVECENTO SP G

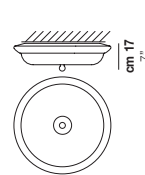
ø cm 64
ø 25"

NOVECENTO PL

ø cm 27
ø 11"
ø cm 30
ø 12"
cm 18
7"

NOVECENTO LT

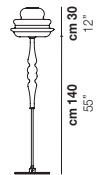
ø cm 44
ø 17"

NOVECENTO PT

codice / code	vetro / glass	struttura / frame	W	lumen @3000K	°K option	dimmer option	Ⓜ	m ³	EU cert.	International cert.	€	
NOVECENTOSP P	BC/RI CR/RI	CR	E14	1×60W		DIM1	2,5	0,07	⚡ IP20	CE	ERL	445,00
NOVECENTOSP M	BC/RI CR/RI	CR	E27	1×77W		DIM1	7,0	0,16	⚡ IP20	CE	ERL	810,00
NOVECENTOSP G	BC/RI CR/RI	CR	E14	5×60W		DIM1	17,0	0,54	⚡ IP20	CE	ERL	2.450,00
NOVECENTOPL	BC/RI CR/RI	CR	E14	5×60W		DIM1	9,0	0,25	⚡ IP20	CE	ERL	1.195,00
NOVECENTOLT	BC/RI CR/RI	CR	E14	1×60W		ON/OFF	6,0	0,10	⚡ IP20	CE	ERL	675,00
NOVECENTOPT	BC/RI CR/RI	CR	E27	1×77W		ON/OFF*	17,0	0,35	⚡ IP20	CE	ERL	1.490,00

* Vedi nota pagina 8 / See note on page 8

finitura vetro / glass finish | finitura struttura / frame finish

New**ORO**

design Vistosi 2019

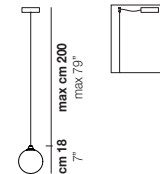

CR/BC | CR/TR | NN | OG

ø cm 16
ø 6"

ORO SP P

codice / code	vetro / glass	struttura / frame	W	lumen @3000K	°K option	dimmer option	Ⓜ	m ³	EU cert.	International cert.	€		
OROSP P	CR/BC CR/TR	NN OG	G9	1×60W		DIM1	1,5	0,04	⚡ IP20	CE	ERL	405,00	
OROSP P	CR/BC CR/TR	NN OG	NEW LED B	9W	1200	2700 3000	DIM2 DIM3	1,5	0,04	⚡ IP20	CE	ERL	555,00

finitura vetro / glass finish | finitura struttura / frame finish

OTO

design Pio e Tito Toso 2015

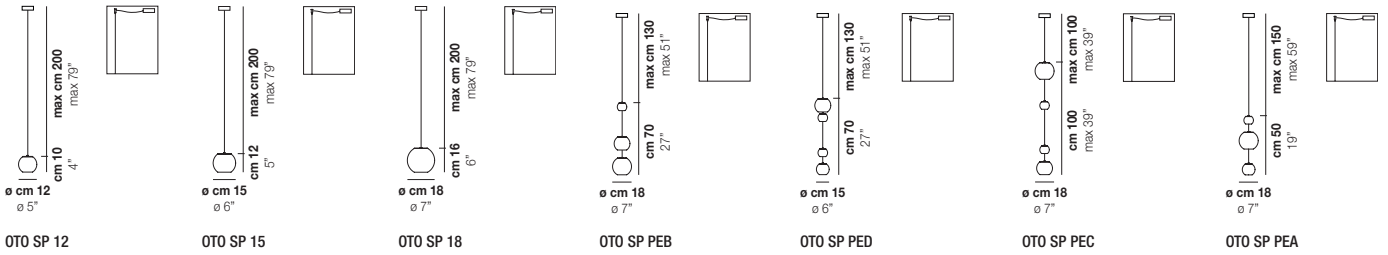

codice / code	vetro / glass	struttura / frame	W	lumen @3000K	°K option	dimmer option	⚡	m³	EU cert.	International cert.	€
OTO SP 12*	AM/RI BC/RI CR/RI FU/RI	NI	G9	1×60W		DIM1	1,0	0,02	IP20	CE CB EAC	175,00
OTO SP 15*	AM/RI BC/RI CR/RI FU/RI	NI	G9	1×60W		DIM1	1,0	0,02	IP20	CE CB EAC	185,00
OTO SP 18*	AM/RI BC/RI CR/RI FU/RI	NI	G9	1×60W		DIM1	3,0	0,02	IP20	CE CB EAC	205,00
OTO SP PEB	AM/RI BC/RI CR/RI FU/RI	NI	G9	1×60W		DIM1	3,0	0,07	IP20	CE CB EAC	385,00
OTO SP PED	AM/RI BC/RI CR/RI FU/RI	NI	G9	1×60W		DIM1	3,0	0,07	IP20	CE CB EAC	430,00
OTO SP PEC	AM/RI BC/RI CR/RI FU/RI	NI	G9	1×60W		DIM1	3,0	0,07	IP20	CE CB EAC	465,00
OTO SP PEA	AM/RI BC/RI CR/RI FU/RI	NI	G9	1×60W		DIM1	3,0	0,07	IP20	CE CB EAC	490,00

* **Attenzione, modello modificato:** ora fornito con rosone metallico / **Attention, model modified:** now supplied with metal canopy

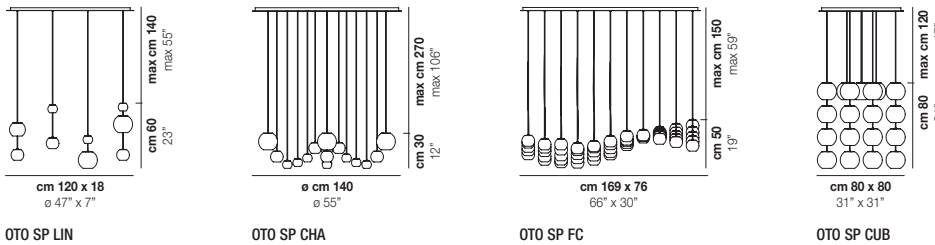

codice / code	vetro / glass	struttura / frame	W	lumen @3000K	°K option	dimmer option	⚡	m³	EU cert.	International cert.	€
OTO SP LIN	AM/RI BC/RI CR/RI FU/RI	BC	G9	4×60W		DIM1	6,0	0,18	IP20	CE CB EAC	1.195,00
OTO SP LIN	AM/RI BC/RI CR/RI FU/RI	AS NI	G9	4×60W		DIM1	6,0	0,18	IP20	CE CB EAC	1.240,00
OTO SP CHA	AM/RI BC/RI CR/RI FU/RI	BC	G9	9×60W		DIM1	75,0	0,83	IP20	CE CB EAC	5.785,00
OTO SP CHA	AM/RI BC/RI CR/RI FU/RI	AS NI	G9	9×60W		DIM1	75,0	0,83	IP20	CE CB EAC	6.220,00
OTO SP FC	AM/RI BC/RI CR/RI FU/RI	BC	G9	12×60W		DIM1	60,0	0,82	IP20	CE CB EAC	6.070,00
OTO SP FC	AM/RI BC/RI CR/RI FU/RI	AS NI	G9	12×60W		DIM1	60,0	0,82	IP20	CE CB EAC	6.350,00
OTO SP CUB	AM/RI BC/RI CR/RI FU/RI	BC	G9	16×60W		DIM1	60,0	1,18	IP20	CE CB EAC	7.530,00
OTO SP CUB	AM/RI BC/RI CR/RI FU/RI	AS NI	G9	16×60W		DIM1	60,0	1,18	IP20	CE CB EAC	7.740,00

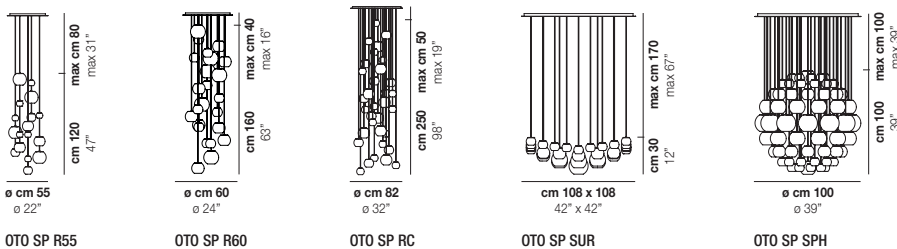

codice / code	vetro / glass	struttura / frame	W	lumen @3000K	°K option	dimmer option	⚡	m³	EU cert.	International cert.	€
OTO SP R55	AM/RI BC/RI CR/RI FU/RI	BC	G9	9×60W		DIM1	15,0	0,33	IP20	CE CB EAC	2.170,00
OTO SP R55	AM/RI BC/RI CR/RI FU/RI	AS NI	G9	9×60W		DIM1	15,0	0,33	IP20	CE CB EAC	2.390,00
OTO SP R60	AM/RI BC/RI CR/RI FU/RI	BC	G9	10×60W		DIM1	23,0	0,56	IP20	CE CB EAC	3.195,00

codice / code	vetro / glass	struttura / frame	W	lumen @3000K	°K option	dimmer option		m³	EU cert.	International cert.	€
OTOSP R60	AM/RI BC/RI CR/RI FU/RI	AS NI	G9	10×60W		DIM1		23,0 0,56			3.420,00
OTOSP RC	AM/RI BC/RI CR/RI FU/RI	BC	G9	12×60W		DIM1		35,0 0,75			4.705,00
OTOSP RC	AM/RI BC/RI CR/RI FU/RI	AS NI	G9	12×60W		DIM1		35,0 0,75			5.550,00
OTOSP SUR	AM/RI BC/RI CR/RI FU/RI	BC	G9	17×60W		DIM1		60,0 0,98			6.135,00
OTOSP SUR	AM/RI BC/RI CR/RI FU/RI	AS NI	G9	17×60W		DIM1		60,0 0,98			6.500,00
OTOSP SPH	AM/RI BC/RI CR/RI FU/RI	BC	G9	13×60W		DIM1		85,0 1,30			11.120,00
OTOSP SPH	AM/RI BC/RI CR/RI FU/RI	AS NI	G9	13×60W		DIM1		85,0 1,30			11.415,00

finitura vetro / glass finish

OVALINA

design Vistosi 1993

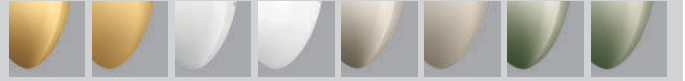

AM/LU AM/ST BC/LU BC/ST FU/LU FU/ST VA/LU VA/ST

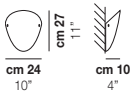

OVALINA AP

codice / code	vetro / glass	struttura / frame	W	lumen @3000K	°K option	dimmer option		m³	EU cert.	International cert.	€
OVALINA AP	BC/LU BC/ST		E27	1×77W		DIM1		0,7 0,03			145,00
F OVALINA AP	AM/LU AM/ST FU/LU FU/ST VA/LU VA/ST		E27	1×77W		DIM1		0,7 0,03			170,00

finitura vetro / glass finish | finitura struttura / frame finish

PEGGY

design Hangar Group 2014

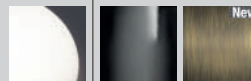

BC/LU NEL OT

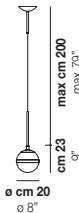

PEGGY SP

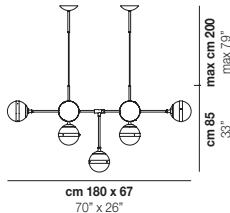

PEGGY SP 9

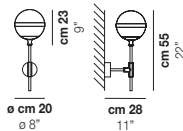

PEGGY AP

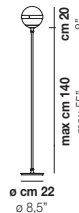

PEGGY PT

codice / code	vetro / glass	struttura / frame	W	lumen @3000K	°K option	dimmer option		m³	EU cert.	International cert.	€
PEGGY SP	BC/LU	NEL	E14	1×60W		DIM1		3,0 0,07			390,00
PEGGY SP	BC/LU	OT	E14	1×60W		DIM1		3,0 0,07			415,00
PEGGY SP 9	BC/LU	NEL	E14	9×60W		DIM1		30,0 0,40			3.475,00
PEGGY SP 9	BC/LU	OT	E14	9×60W		DIM1		30,0 0,40			3.640,00
PEGGY AP	BC/LU	NEL	E14	1×60W		DIM1		3,0 0,07			490,00
PEGGY AP	BC/LU	OT	E14	1×60W		DIM1		3,0 0,07			515,00
New PEGGY PT	BC/LU	NEL	E14	1×60W		ON/OFF*		10,0 0,14			655,00
New PEGGY PT	BC/LU	OT	E14	1×60W		ON/OFF*		10,0 0,14			745,00

* Vedi nota pagina 8 / See note on page 8

New

PHOENIX

design Andrea Lazzari 2019

finitura vetro / glass finish

finitura struttura / frame finish

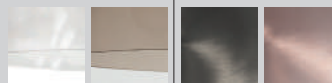

CR/TR

FU/TR

NNS

RAV

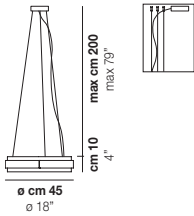

PHOENIX SP

codice / code	vetro / glass	struttura / frame	W	lumen @3000K	°K option	dimmer option	m³	EU cert.	International cert.	€
PHOENIX SP	CR/TR FU/TR	NNS RAV	LED 08 35W	3800	2700 3000	DIM2	4,0 0,16	CE	ERC	1.620,00

New

PLOT

design Chiamonte & Marin 2019

finitura vetro / glass finish

finitura struttura / frame finish



CR/NE

CR/OT

FU/NE

FU/OT

NEO

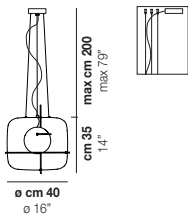

PLOT SP

codice / code	vetro / glass	struttura / frame	W	lumen @3000K	°K option	dimmer option	m³	EU cert.	International cert.	€
PLOT SP	CR/NE CR/OT FU/NE FU/OT	NEO	LED 09 11W	1700	2700 3000	DIM2 DIM3	9,0 0,23	CE	ERC	1.165,00

New

PLOT FRAME

design Chiamonte & Marin 2020

finitura vetro / glass finish

finitura struttura / frame finish



BC/LU

NEO

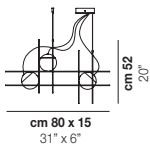

PLOT FRAME SP 3

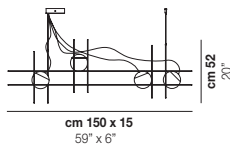

PLOT FRAME SP 4

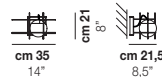

PLOT FRAME AP 1

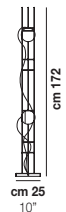

PLOT FRAME PT 2

codice / code	vetro / glass	struttura / frame	W	lumen @3000K	°K option	dimmer option	m³	EU cert.	International cert.	€
PLOT FRAME SP 3	BC/LU	NEO	LED 17 3x8,5W	3750	2700 3000	DIM2 DIM3	10,0 0,13	CE	ERC	1.374,00
PLOT FRAME SP 4	BC/LU	NEO	LED 17 4x8,5W	5000	2700 3000	DIM2 DIM3	15,0 0,13	CE	ERC	1.748,00
PLOT FRAME AP 1	BC/LU	NEO	LED 09 1x11W	1700	2700 3000	DIM2 DIM3	5,0 0,08	CE	ERC	475,00
PLOT FRAME PT 2	BC/LU	NEO	LED 09 2x11W	3400	2700 3000	DIM4	14,0 0,33	CE	ERC	1.249,00

finitura vetro / glass finish | finitura struttura / frame finish

POC

design Barbara Maggiolo 2003



CR/BC

NI

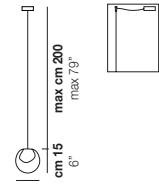

o cm 16
o 6"

POC SP 16



o cm 23
o 9"

POC SP 25



o cm 16
o 6"

POC FA 16



cm 19
7"



o cm 16
o 6"

POC LT 16

codice / code	vetro / glass	struttura / frame	W	lumen @3000K	°K option	dimmer option	m³	EU cert.	International cert.	€
POC SP 16*	CR/BC	NI	G9	1×60W		DIM1	1,0 0,04	IP20	CE CB EAC PS	420,00
POC SP 16	CR/BC	NI	LED B	9W	1200	2700 3000	1,0 0,04	IP20	CE EAC	570,00
POC SP 25	CR/BC	NI	G9	1×60W		DIM1	2,5 0,05	IP20	CE EAC PS	615,00
POC FA 16	CR/BC	NI	G9	1×60W		DIM1	1,0 0,04	IP20	CE CB EAC PS	425,00
POC FA 16	CR/BC	NI	LED D	9W	1200	2700 3000	1,0 0,04	IP20	CE EAC	585,00
POC LT 16	CR/BC	NI	G9	1×60W		ON/OFF	2,0 0,04	IP20	CE EAC PS	425,00

* **Attenzione, modello modificato:** ora fornito con rosone metallico / **Attention, model modified:** now supplied with metal canopy

finitura vetro / glass finish | finitura struttura / frame finish

POD

design Babled & Co. 2005



BC/LU

BC

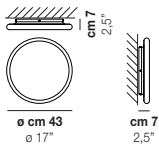

POD PP P

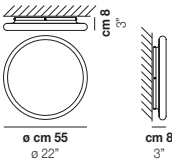

POD PP G

codice / code	vetro / glass	struttura / frame	W	lumen @3000K	°K option	dimmer option	m³	EU cert.	International cert.	€
POD PPP	BC/LU	BC	LED 18	12W	1900	2700 3000	6,0 0,07	IP20	CE EAC	745,00
POD PPG	BC/LU	BC	LED 19	18W	2800	2700 3000	6,0 0,13	IP20	CE EAC	995,00

finitura vetro / glass finish | finitura struttura / frame finish

PUPPET

design Romani Saccani Architetti Associati 2015



AM/TR

BC/SF

CR/TR

FU/TR

MC/1

MC/2

MC/3

CR

NE

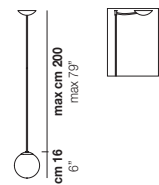

o cm 16
o 6"

PUPPET SP P

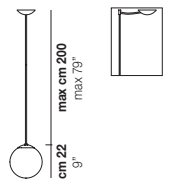

o cm 22
o 9"

PUPPET SP M

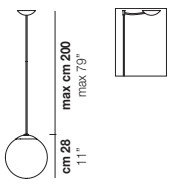

o cm 28
o 11"

PUPPET SP G

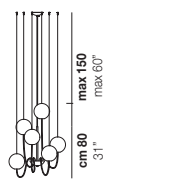

max o cm 80
max o 32"



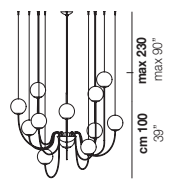



PUPPET SP 6 P



max o cm 130
max o 52"

PUPPET SP 12 P

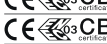
codice / code	vetro / glass	struttura / frame	W	lumen @3000K	°K option	dimmer option	m³	EU cert.	International cert.	€
PUPPET SP P	AM/TR BC/SF CR/TR FU/TR	CR NE	G9	1×60W		DIM1	1,5 0,04	IP20	CE CB EAC PS	240,00
PUPPET SP M	AM/TR BC/SF CR/TR FU/TR	CR NE	G9	1×60W		DIM1	2,5 0,05	IP20	CE CB EAC PS	295,00

codice / code	vetro / glass	struttura / frame	W	lumen @3000K	°K option	dimmer option	Δ	m ³	EU cert.	International cert.	€
PUPPET SP G	AM/TR BC/SF CR/TR FU/TR	CR NE	G9	1×60W		DIM1	Δ	3,5 0,08	\perp IP20	CE  CB ENEC 	345,00
PUPPET SP 6P	AM/TR BC/SF CR/TR FU/TR MC/1 MC/2 MC/3	CR NE	G9	6×60W		DIM1	Δ	9,0 0,16	\perp IP20	CE  CB ENEC 	1.260,00
PUPPET SP 12P	AM/TR BC/SF CR/TR FU/TR MC/1 MC/2 MC/3	CR NE	G9	12×60W		DIM1	Δ	17,0 0,31	\perp IP20	CE  CB ENEC 	2.570,00

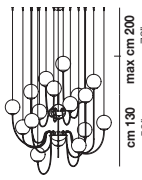

max ø cm 130
max ø 52°

PUPPET SP 18 P

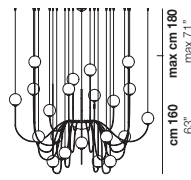

max ø cm 190
max ø 75°

PUPPET SP 24 P

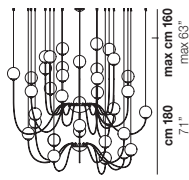

max ø cm 190
max ø 75°

PUPPET SP 36 P

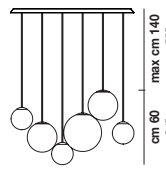





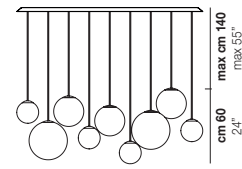



cm 91 x 35
36" x 14"

PUPPET SP L6



cm 136 x 38
54" x 15"

PUPPET SP L9

codice / code	vetro / glass	struttura / frame	W	lumen @3000K	°K option	dimmer option	Δ	m ³	EU cert.	International cert.	€
PUPPET SP 18P	AM/TR BC/SF CR/TR FU/TR MC/1 MC/2 MC/3	CR NE	G9	18×60W		DIM1	Δ	26,0 0,52	\perp IP20	CE  CB ENEC 	3.835,00
PUPPET SP 24P	AM/TR BC/SF CR/TR FU/TR MC/1 MC/2 MC/3	CR NE	G9	24×60W		DIM1	Δ	34,0 0,62	\perp IP20	CE  CB ENEC 	5.115,00
PUPPET SP 36P	AM/TR BC/SF CR/TR FU/TR MC/1 MC/2 MC/3	CR NE	G9	36×40W		DIM1	Δ	42,0 0,80	\perp IP20	CE  CB ENEC 	7.660,00
PUPPET SP L6	AM/TR BC/SF CR/TR FU/TR MC/1 MC/2 MC/3	CR NE	G9	6×60W		DIM1	Δ	12,0 0,30	\perp IP20	CE 	1.800,00
PUPPET SP L9	AM/TR BC/SF CR/TR FU/TR MC/1 MC/2 MC/3	CR NE	G9	9×60W		DIM1	Δ	20,0 0,45	\perp IP20	CE 	2.700,00

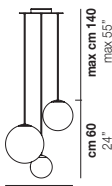

ø cm 50
ø 20°

PUPPET SP R3

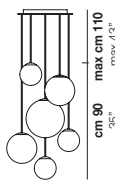

ø cm 58
ø 23°

PUPPET SP R6

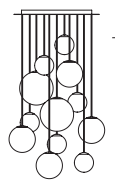

ø cm 83
ø 33°

PUPPET SP R12

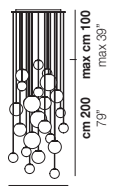

ø cm 108
ø 39°

PUPPET SP R24

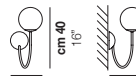











cm 21
8"

PUPPET AP P



ø cm 16
ø 6°

PUPPET LT P

codice / code	vetro / glass	struttura / frame	W	lumen @3000K	°K option	dimmer option	Δ	m ³	EU cert.	International cert.	€
PUPPET SP R3	AM/TR BC/SF CR/TR FU/TR MC/1 MC/2 MC/3	CR NE	G9	3×60W		DIM1	Δ	6,0 0,20	\perp IP20	CE  CB ENEC 	1.315,00
PUPPET SP R6	AM/TR BC/SF CR/TR FU/TR MC/1 MC/2 MC/3	CR NE	G9	6×60W		DIM1	Δ	12,0 0,30	\perp IP20	CE  CB ENEC 	2.025,00
PUPPET SP R12	AM/TR BC/SF CR/TR FU/TR MC/1 MC/2 MC/3	CR NE	G9	12×60W		DIM1	Δ	19,0 0,66	\perp IP20	CE  CB ENEC 	3.695,00
PUPPET SP R24	AM/TR BC/SF CR/TR FU/TR MC/1 MC/2 MC/3	CR NE	G9	24×60W		DIM1	Δ	64,0 1,36	\perp IP20	CE  CB ENEC 	6.735,00
PUPPET AP P	AM/TR BC/SF CR/TR FU/TR	CR NE	G9	1×60W		DIM1	Δ	2,0 0,05	\perp IP20	CE 	320,00
PUPPET LTP	AM/TR BC/SF CR/TR FU/TR	CR NE	G9	1×60W		ON/OFF	Δ	2,5 0,05	\perp IP20	CE 	285,00

NE struttura nera, cavo nero / black frame, black cable

CR struttura cromo, cavo grigio / chrome frame, grey cable

MC/1 vetro / glass AM/TR + CR/TR + FU/TR

MC/2 vetro / glass AM/TR + CR/TR

MC/3 vetro / glass CR/TR + FU/TR

New

PUPPET RING

design Romani Sacconi Architetti Associati 2019

finitura vetro / glass finish | finitura struttura / frame finish

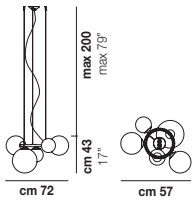

PUPPET RING SP 5

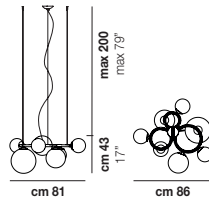

PUPPET RING SP 7

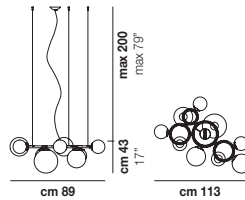

PUPPET RING SP 9

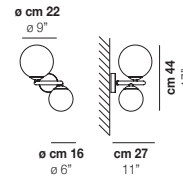

PUPPET RING AP 2

codice / code	vetro / glass	struttura / frame	W	lumen @3000K	°K option	dimmer option	⚡	m ³	EU cert.	International cert.	€
PUPPET RING SP 5	AM/TR BC/SF CR/TR FU/TR	BKS NNS	G9	5×60W		DIM1		10,0 0,30	IP20	CE EAC	1.985,00
PUPPET RING SP 7	AM/TR BC/SF CR/TR FU/TR	BKS NNS	G9	7×60W		DIM1		16,0 0,38	IP20	CE EAC	2.655,00
PUPPET RING SP 9	AM/TR BC/SF CR/TR FU/TR	BKS NNS	G9	9×60W		DIM1		20,0 0,77	IP20	CE EAC	3.590,00
PUPPET RING AP 2	AM/TR BC/SF CR/TR FU/TR	BKS NNS	G9	2×60W		DIM1		4,0 0,11	IP20	CE EAC	665,00

New

RIFLESSO

design Chiaramonte & Marin 2019

finitura vetro / glass finish | finitura struttura / frame finish

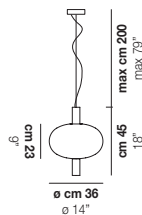
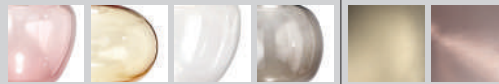

RIFLESSO SP 1

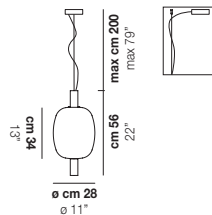

RIFLESSO SP 2

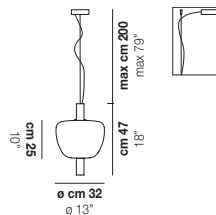

RIFLESSO SP 3

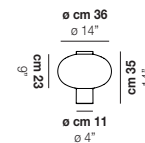

RIFLESSO LT 1

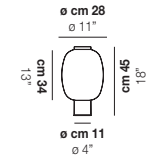

RIFLESSO LT 2

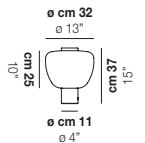

RIFLESSO LT 3

codice / code	vetro / glass	struttura / frame	W	lumen @3000K	°K option	dimmer option	⚡	m ³	EU cert.	International cert.	€
RIFLESSOSP1	AM/TR CR/TR	BKS RAV	LED 10	12,5W 1500	2700 3000	DIM2 DIM3		7,0 0,12	IP20	CE EAC	695,00
RIFLESSOSP2	CR/TR FU/TR	BKS RAV	LED 10	12,5W 1500	2700 3000	DIM2 DIM3		7,0 0,12	IP20	CE EAC	695,00
RIFLESSOSP3	AA/TR CR/TR	BKS RAV	LED 10	12,5W 1500	2700 3000	DIM2 DIM3		7,0 0,12	IP20	CE EAC	695,00
RIFLESSOLT1	AM/TR CR/TR	BKS RAV	LED 05	10,5W 1400	2700 3000	DIM4		5,0 0,12	IP20	CE EAC	670,00
RIFLESSOLT2	CR/TR FU/TR	BKS RAV	LED 05	10,5W 1400	2700 3000	DIM4		5,0 0,12	IP20	CE EAC	670,00
RIFLESSOLT3	AA/TR CR/TR	BKS RAV	LED 05	10,5W 1400	2700 3000	DIM4		5,0 0,12	IP20	CE EAC	670,00

finitura vetro / glass finish | finitura struttura / frame finish

RIGA

design Vistosi 2002

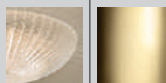

CR/GA | OR

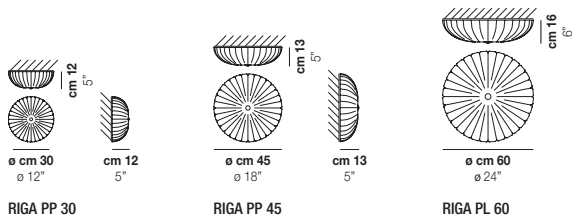

codice / code	vetro / glass	struttura / frame	W	lumen @3000K	°K option	dimmer option	m³	EU cert.	International cert.	€
F RIGAPP30	CR/GA	OR	E14	2x60W		DIM1	3,5 0,05	IP20	CE ENEC CB ETL	215,00
F RIGAPP45	CR/GA	OR	E27	3x77W		DIM1	6,3 0,11	IP20	CE ENEC CB ETL	315,00
F RIGAPL60	CR/GA	OR	E27	3x77W		DIM1	10,4 0,25	IP20	CE ENEC CB ETL	495,00

finitura vetro / glass finish | finitura struttura / frame finish

RINA

design Barbara Maggiolo 2009

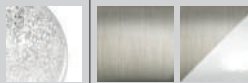

BC/MU | NI | NIB

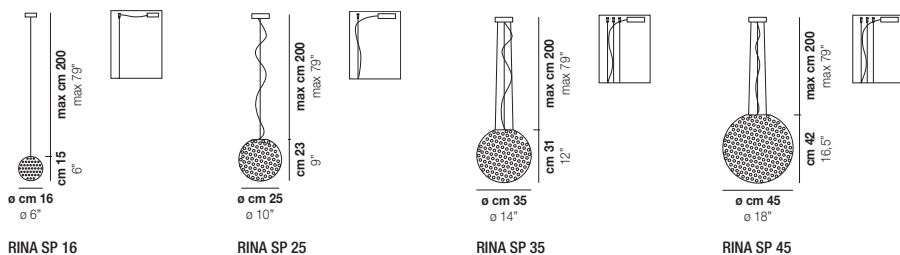

codice / code	vetro / glass	struttura / frame	W	lumen @3000K	°K option	dimmer option	m³	EU cert.	International cert.	€
RINA SP16*	BC/MU	NI	G9	1x60W		DIM1	1,0 0,04	IP20	CE ENEC CB ETL	310,00
RINA SP16	BC/MU	NI	NEW LED B	9W 1200	2700 3000	DIM2 DIM3	1,0 0,04	IP20	CE ENEC CB ETL	460,00
RINA SP25	BC/MU	NI	E27	1x77W		DIM1	1,5 0,07	IP20	CE ENEC CB ETL	445,00
RINA SP35	BC/MU	NI	E27	1x77W		DIM1	6,0 0,16	IP20	CE ENEC CB ETL	665,00
RINA SP45	BC/MU	NI	E27	3x77W		DIM1	11,0 0,23	IP20	CE ENEC CB ETL	915,00

* **Attenzione, modello modificato:** ora fornito con rosone metallico / **Attention, model modified:** now supplied with metal canopy

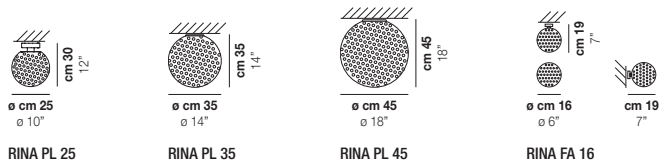

codice / code	vetro / glass	struttura / frame	W	lumen @3000K	°K option	dimmer option	m³	EU cert.	International cert.	€
RINA PL25	BC/MU	NI	E27	1x77W		DIM1	5,0 0,07	IP20	CE ENEC CB ETL	445,00
RINA PL35	BC/MU	NI	E27	1x77W		DIM1	5,5 0,16	IP20	CE ENEC CB ETL	460,00
RINA PL45	BC/MU	NI	E27	3x77W		DIM1	8,0 0,23	IP20	CE ENEC CB ETL	620,00
RINA FA16	BC/MU	NI	G9	1x60W		DIM1	1,5 0,04	IP20	CE ENEC CB ETL	285,00
RINA FA16	BC/MU	NI	NEW LED D	9W 1200	2700 3000	DIM2 DIM3	1,5 0,04	IP20	CE ENEC CB ETL	445,00



RINALT 16



RINALT 25



RINALT 35

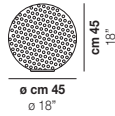

RINALT 45



RINA PT 100

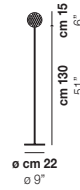

RINA PT 140

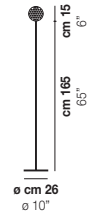

RINA PT 180

codice / code	vetro / glass	struttura / frame	W	lumen @3000K	°K option	dimmer option	⊲	m³	EU cert.	International cert.	€
RINALT 16	BC/MU	NI	G9	1×60W		ON/OFF	2,0	0,04	IP20	CE ENEC CB ETL ETL USA PS	380,00
RINALT 25	BC/MU	NI	E27	1×77W		ON/OFF	2,0	0,07	IP20	CE ENEC CB ETL ETL USA PS	430,00
RINALT 35	BC/MU	NI	E27	1×77W		ON/OFF	4,0	0,16	IP20	CE ENEC CB ETL ETL USA PS	765,00
RINALT 45	BC/MU	NI	E27	1×77W		ON/OFF	9,0	0,23	IP20	CE ENEC CB ETL ETL USA PS	965,00
RINAPT 100	BC/MU	NI	G9	1×60W		ON/OFF	5,0	0,13	IP20	CE ENEC CB ETL ETL USA PS	450,00
RINAPT 140	BC/MU	NI	G9	1×60W		ON/OFF	5,0	0,14	IP20	CE ENEC CB ETL ETL USA PS	480,00
RINAPT 180	BC/MU	NI	G9	1×60W		ON/OFF	5,0	0,14	IP20	CE ENEC CB ETL ETL USA PS	490,00

finitura vetro / glass finish | finitura struttura / frame finish



BC/ST | BC | BO

SABA

design Vistosi 1998

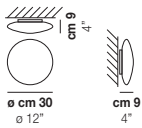

SABA PP 30

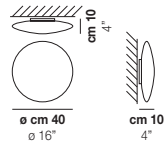

SABA PP 40

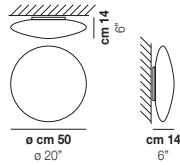

SABA PP 50

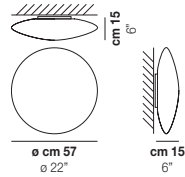

SABA PP 60

codice / code	vetro / glass	struttura / frame	W	lumen @3000K	°K option	dimmer option	⊲	m³	EU cert.	International cert.	€
SABAPP 30	BC/ST	BC	E27	1×77W		DIM1	3,0	0,03	IP20	CE ENEC CB ETL ETL USA PS	165,00
SABAPP 30	BC/ST	BO	LED F	12W 1700	2700 3000	DIM2 DIM3	3,0	0,03	IP20	CE ENEC CB ETL ETL USA PS	305,00
SABAPP 40	BC/ST	BC	E27	1×77W		DIM1	3,5	0,05	IP20	CE ENEC CB ETL ETL USA PS	240,00
SABAPP 40	BC/ST	BO	LED G	19W 2850	2700 3000	DIM2 DIM3	3,5	0,05	IP20	CE ENEC CB ETL ETL USA PS	400,00
SABAPP 50	BC/ST	BC	E27	2×77W		DIM1	4,0	0,07	IP20	CE ENEC CB ETL ETL USA PS	365,00
SABAPP 50	BC/ST	BO	LED G	19W 2850	2700 3000	DIM2 DIM3	4,0	0,07	IP20	CE ENEC CB ETL ETL USA PS	525,00
SABAPP 60	BC/ST	BC	E27	3×77W		DIM1	4,5	0,16	IP20	CE ENEC CB ETL ETL USA PS	590,00
SABAPP 60	BC/ST	BO	LED O	26W 3700	2700 3000	DIM2	4,5	0,16	IP20	CE ENEC CB ETL ETL USA PS	790,00

SATA

design Favaretto&Partners 2017

finitura vetro / glass finish

finitura struttura / frame finish

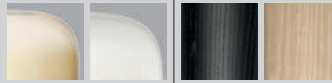

AM/SF

BC/SF

LFN

LFR

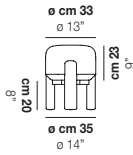

SATA LT

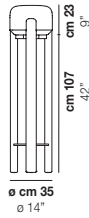

SATA PT

codice / code	vetro / glass	struttura / frame	W	lumen @3000K	°K option	dimmer option	m³	EU cert.	International cert.	€
SATALT	AM/SF BC/SF	LFN LFR	E27	1×77W		ON/OFF	6,0 0,14 ± IP20	CE	ERL	740,00
SATAPT	AM/SF BC/SF	LFN LFR	E27	1×77W		ON/OFF	15,0 0,21 ± IP20	CE	ERL	1.060,00

New**SCINTILLA**

design Giovanni Barbato 2019

finitura vetro / glass finish

finitura struttura / frame finish

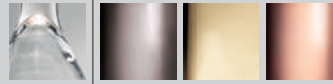

CR/TR

BH

OG

RA

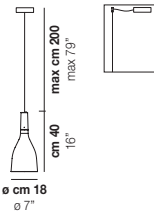

SCINTILLA SP

codice / code	vetro / glass	struttura / frame	W	lumen @3000K	°K option	dimmer option	m³	EU cert.	International cert.	€
SCINTILLASP	CR/TR	BH OG RA	LED 11	12W 1600	2700 3000	DIM2 DIM3	3,0 0,07 ± IP20	CE	ERL	550,00

finitura vetro / glass finish

finitura struttura / frame finish



BC/LU

BC

SEMAI

design Alberto Saggia e Valerio Sommella 2015

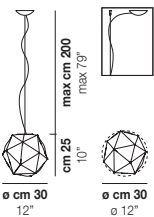

SEMAI SP P

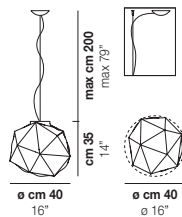

SEMAI SP M

codice / code	vetro / glass	struttura / frame	W	lumen @3000K	°K option	dimmer option	m³	EU cert.	International cert.	€
F SEMAISPP	BC/LU	BC	E27	1×77W		DIM1	3,0 0,10 ± IP20	CE	CB certificate ERL	485,00
SEMAISPM*	BC/LU	BC	E27	1×77W		DIM1	6,0 0,16 ± IP20	CE	CB certificate ERL	665,00

* Attenzione modello modificato / Attention, model modified

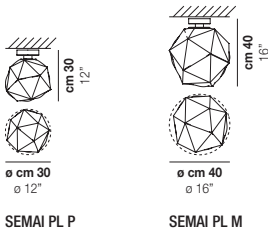

SEMAI PL P

SEMAI PL M

codice / code	vetro / glass	struttura / frame	W	lumen @3000K	°K option	dimmer option	$\frac{lm}{m^2}$	m ³	EU cert.	International cert.	€
F SEMAI PL P	BCLU	BC	E14	1x46W		DIM1	3,0	0,10	⚡ IP20	CE CB certificate EAC CB certificate	305,00
SEMAI PL M*	BCLU	BC	E27	1x77W		DIM1	6,0	0,16	⚡ IP20	CE CB certificate EAC CB certificate	530,00

* Attenzione modello modificato / Attention, model modified

finitura vetro / glass finish | finitura struttura / frame finish

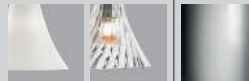

BC/LU | CR/RI | CR

SISSI

design Barbara Maggiolo 2009

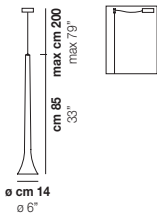

SISSI SP

codice / code	vetro / glass	struttura / frame	W	lumen @3000K	°K option	dimmer option	$\frac{lm}{m^2}$	m ³	EU cert.	International cert.	€
SISSI SP	BCLU	CR	GU10	1x75W		DIM1	2,0	0,06	⚡ IP20	CE EAC CB certificate	385,00
SISSI SP	CR/RI	CR	GU10	1x75W		DIM1	2,0	0,06	⚡ IP20	CE EAC CB certificate	425,00

finitura vetro / glass finish | finitura struttura / frame finish



BC/CR | NI

SMOKING

design Paolo Crepax 2003

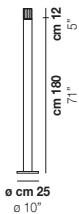

SMOKING PT

codice / code	vetro / glass	struttura / frame	W	lumen @3000K	°K option	dimmer option	$\frac{lm}{m^2}$	m ³	EU cert.	International cert.	€
F SMOKING PT	BC/CR	NI	E27	1x77W		ON/OFF	12,0	0,33	⚡ IP20	CE EAC CB certificate	1.260,00

finitura vetro / glass finish

finitura struttura / frame finish

SOFT

design Vistosi 1998



BC

BC

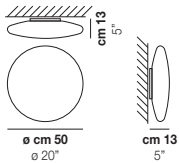

SOFT PP 50 3

codice / code	vetro / glass	struttura / frame	W	lumen @3000K	°K option	dimmer option		m³	EU cert.	International cert.	€	
SOFTPP503	BC	BC	E27	3×77W		DIM1		4,4	0,13			255,00

finitura vetro / glass finish

finitura struttura / frame finish

SOGNO

design Vistosi 2003



BC/ST

BC

BO

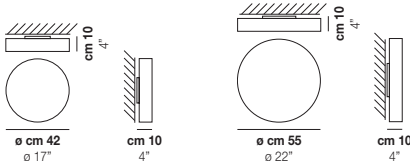

SOGNO PP 42

SOGNO PP 55

codice / code	vetro / glass	struttura / frame	W	lumen @3000K	°K option	dimmer option		m³	EU cert.	International cert.	€	
SOGNO PP 42	BC/ST	BC	E27	2×77W		DIM1		4,5	0,07			265,00
SOGNO PP 42	BC/ST	BO	LED G	19W	2850	2700 3000	DIM2 DIM3	4,5	0,07			425,00
SOGNO PP 55	BC/ST	BC	E27	2×77W		DIM1		7,0	0,13			460,00
SOGNO PP 55	BC/ST	BO	LED G	19W	2850	2700 3000	DIM2 DIM3	7,0	0,13			620,00

finitura vetro / glass finish

finitura struttura / frame finish

SPIRIT

design Marco Acerbis 2013



BC/LU

CR/TR

BC

BO

NI

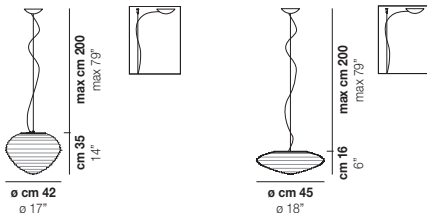

SPIRIT SP 37

SPIRIT SP 45

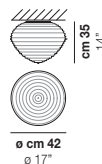

SPIRIT PL 37

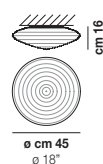

SPIRIT PP 45

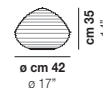

SPIRIT LT 37

codice / code	vetro / glass	struttura / frame	W	lumen @3000K	°K option	dimmer option		m³	EU cert.	International cert.	€	
SPIRIT SP 37	BC/LU CR/TR	NI	E27	1×77W		DIM1		5,0	0,16			470,00
SPIRIT SP 37	BC/LU	BO	LED F	12W	1700	2700 3000	DIM2 DIM3	5,0	0,16			620,00
SPIRIT SP 45	BC/LU CR/TR	NI	E27	2×77W		DIM1		5,0	0,13			450,00
SPIRIT SP 45	BC/LU	BO	LED G	19W	2850	2700 3000	DIM2 DIM3	5,0	0,13			600,00

codice / code	vetro / glass	struttura / frame	W	lumen @3000K	°K option	dimmer option	△ ₈₀	m ³	EU cert.	International cert.	€
SPIRITPL37	B/CLU	BC	E27	1×77W		DIM1	5,0	0,16	⊥ IP20	CE CB EAC	390,00
SPIRITPL37	B/CLU	BO	LED F	12W 1700	2700 3000	DIM2 DIM3	5,0	0,16	⊥ IP20	CE EAC	530,00
SPIRITPP45	B/CLU	BC	E27	2×77W		DIM1	5,0	0,07	⊥ IP20	CE CB EAC	370,00
SPIRITPP45	B/CLU	BO	LED G	19W 2850	2700 3000	DIM2 DIM3	5,0	0,07	⊥ IP20	CE EAC	510,00
SPIRITLT37	B/CLU CR/TR	NI	E27	1×77W		ON/OFF	5,0	0,16	□ IP20	CE CB EAC	420,00

finitura vetro / glass finish | finitura struttura / frame finish

STARDUST

design Francesco Lucchese 2015



CR/RI

NN

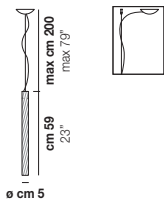

ø cm 5

ø 2"

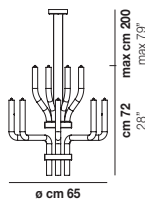
STARDUST SP

ø cm 65

26"

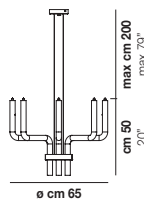
STARDUST SP DOP

ø cm 65

26"

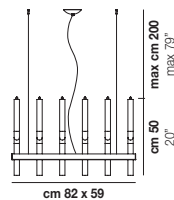
STARDUST SP Q

cm 82 x 59

32" x 23"

STARDUST SP R

codice / code	vetro / glass	struttura / frame	W	lumen @3000K	°K option	dimmer option	△ ₈₀	m ³	EU cert.	International cert.	€
STARDUST SP	CR/RI	NN	G9	1×48W		DIM1	1,5	0,05	⊥ IP20	CE EAC	355,00
STARDUST SP DOP	CR/RI	NN	G9	16×48W		DIM1	13,0	0,27	⊥ IP20	CE EAC	3.290,00
STARDUST SP Q	CR/RI	NN	G9	8×48W		DIM1	9,0	0,22	⊥ IP20	CE EAC	1.725,00
STARDUST SP R	CR/RI	NN	G9	12×48W		DIM1	14,0	0,21	⊥ IP20	CE EAC	3.000,00

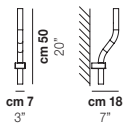

cm 7

3"

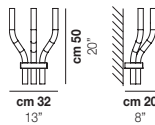
STARDUST AP 1

cm 32

13"

STARDUST AP 3

codice / code	vetro / glass	struttura / frame	W	lumen @3000K	°K option	dimmer option	△ ₈₀	m ³	EU cert.	International cert.	€
STARDUST AP 1	CR/RI	NN	G9	1×60W		DIM1	1,0	0,05	⊥ IP20	CE EAC	270,00
STARDUST AP 3	CR/RI	NN	G9	3×60W		DIM1	4,0	0,08	⊥ IP20	CE EAC	800,00

New

STARNET

design Gianni Veneziano e Luciana Di Virgilio | Veneziano+Team 2015

finitura vetro / glass finish | finitura struttura / frame finish

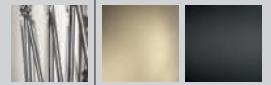

CR

BKS

NEO

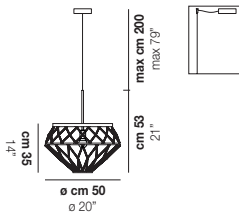

STARNET SP 3

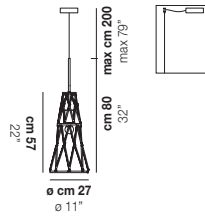

STARNET SP 4

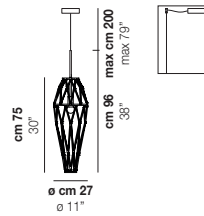

STARNET SP 5

codice / code	vetro / glass	struttura / frame	W	lumen @3000K	°K option	dimmer option	m³	EU cert.	International cert.	€
STARNET SP 3	CR	NEO	E27	1x77W		DIM1	3,0 0,22 \perp IP20	CE	EARL	895,00
STARNET SP 3	CR	BKS	E27	1x77W		DIM1	3,0 0,22 \perp IP20	CE	EARL	990,00
STARNET SP 4	CR	NEO	E27	1x77W		DIM1	2,0 0,22 \perp IP20	CE	EARL	560,00
STARNET SP 4	CR	BKS	E27	1x77W		DIM1	2,0 0,07 \perp IP20	CE	EARL	600,00
STARNET SP 5	CR	NEO	E27	1x77W		DIM1	3,0 0,22 \perp IP20	CE	EARL	710,00
STARNET SP 5	CR	BKS	E27	1x77W		DIM1	3,0 0,07 \perp IP20	CE	EARL	770,00

finitura vetro / glass finish | finitura struttura / frame finish

STONE

design Hangar Group 2017



CR/BC

FU/BC

NN

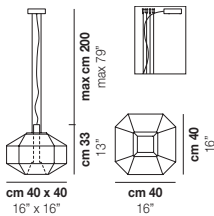

STONE SP

codice / code	vetro / glass	struttura / frame	W	lumen @3000K	°K option	dimmer option	m³	EU cert.	International cert.	€
F STONESP	CR/BC FU/BC	NN	E14	1x48W		DIM1	9,0 0,16 \perp IP20	CE	EARL	840,00
STONESP	CR/BC FU/BC	NN	LED 12	2W+8W 1200	2700 3000	DIM2 DIM3	9,0 0,16 \perp IP20	CE	EARL	1.385,00

finitura vetro / glass finish | finitura struttura / frame finish

SURFACE

design Giovanni Barbato 2017



BC/BC

BC/FU

BC/TB

BC/VA

NI

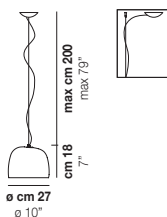

SURFACE SP P

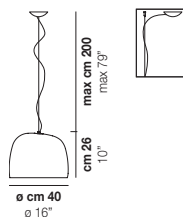

SURFACE SP G

codice / code	vetro / glass	struttura / frame	W	lumen @3000K	°K option	dimmer option	m³	EU cert.	International cert.	€
F SURFACE SP P	BC/BC BC/FU BC/TB BC/VA	NI	E27	1x77W		DIM1	2,5 0,05 \perp IP20	CE	EARL	300,00

codice / code	vetro / glass	struttura / frame	W	lumen @3000K	°K option	dimmer option	⚡	m³	EU cert.	International cert.	€
SURFACE SP G	BC/BC BC/FU BC/TB BC/VA	NI	E27	1×77W		DIM1	5,0	0,10	⚡ IP20	CE CB EAC	370,00
SURFACE SP G	BC/BC BC/FU BC/TB BC/VA	NI	LED C	12W 1600	2700 3000	DIM2 DIM3	5,0	0,10	⚡ IP20	CE CB EAC	535,00

New

TREAD

design Chiaramonte & Marin 2019

finitura vetro / glass finish | finitura struttura / frame finish

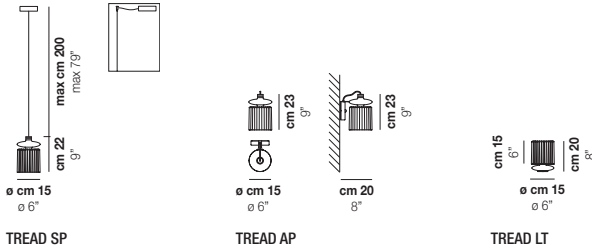
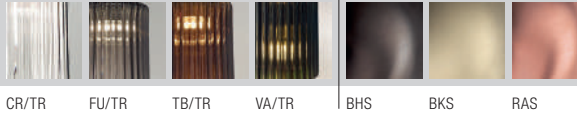

TREAD SP

TREAD AP

TREAD LT

codice / code	vetro / glass	struttura / frame	W	lumen @3000K	°K option	dimmer option	⚡	m³	EU cert.	International cert.	€
TREAD SP*	CR/TR FU/TR TB/TR VA/TR	BHS BKS RAS	LED 13	12W 1600	2700 3000	DIM2 DIM3	6,0	0,04	⚡ IP20	CE EAC	590,00
TREAD AP*	CR/TR FU/TR TB/TR VA/TR	BHS BKS RAS	LED 13	12W 1600	2700 3000	DIM2 DIM3	3,0	0,04	⚡ IP20	CE EAC	645,00
TREAD LT	CR/TR FU/TR TB/TR VA/TR	BHS BKS RAS	E14	1×60W		ON/OFF	3,0	0,04	⚡ IP20	CE EAC	425,00

* Attenzione modello modificato / Attention, model modified

finitura vetro / glass finish | finitura struttura / frame finish

TREPAI

design Favaretto&Partners 2013

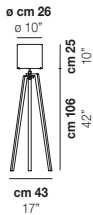
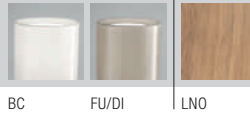

TREPAI PT

codice / code	vetro / glass	struttura / frame	W	lumen @3000K	°K option	dimmer option	⚡	m³	EU cert.	International cert.	€
TREPAIPT	BC	LNO	E27	1×77W		ON/OFF	5,0	0,21	⚡ IP20	CE EAC	760,00
TREPAIPT	FU/DI	LNO	E27	1×77W		ON/OFF	5,0	0,21	⚡ IP20	CE EAC	765,00

finitura vetro / glass finish | finitura struttura / frame finish

TUBES

design Matthias Hickl per Lissoni Associati 2005

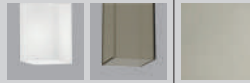

BC/LU FU/TR NO

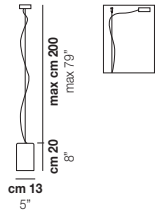

TUBES SP 20

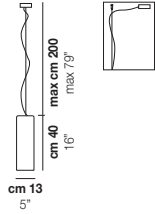

TUBES SP 40

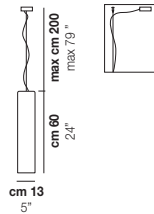

TUBES SP 60

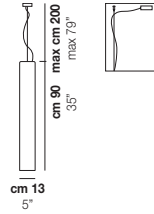

TUBES SP 90

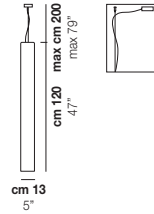

TUBES SP 120

codice / code	vetro / glass	struttura / frame	W	lumen @3000K	°K option	dimmer option	RE	m ³	EU cert.	International cert.	€
TUBES SP 20	BC/LU FU/TR	NO	E27	1x77W		DIM1	2,0	0,07	IP20	CE EAC	450,00
TUBES SP 40	BC/LU FU/TR	NO	E27	1x77W		DIM1	3,5	0,05	IP20	CE EAC	510,00
TUBES SP 60	BC/LU FU/TR	NO	E27	1x77W		DIM1	8,0	0,13	IP20	CE EAC	575,00
TUBES SP 90	BC/LU FU/TR	NO	E27	1x77W		DIM1	6,0	0,14	IP20	CE EAC	790,00
TUBES SP 120	BC/LU FU/TR	NO	E27	1x77W		DIM1	8,0	0,14	IP20	CE EAC	1.015,00

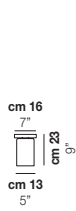

TUBES PL 20

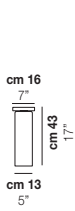

TUBES PL 40

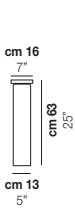

TUBES PL 60

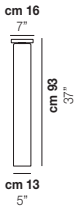

TUBES PL 90



TUBES PL 120



TUBES PL 9

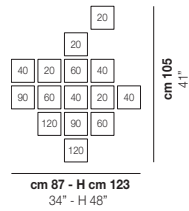

TUBES PL 15

codice / code	vetro / glass	struttura / frame	W	lumen @3000K	°K option	dimmer option	RE	m ³	EU cert.	International cert.	€
TUBES PL 20	BC/LU FU/TR	NO	E27	1x77W		DIM1	2,5	0,07	IP20	CE EAC	405,00
TUBES PL 40	BC/LU FU/TR	NO	E27	1x77W		DIM1	3,5	0,05	IP20	CE EAC	485,00
TUBES PL 60	BC/LU FU/TR	NO	E27	1x77W		DIM1	4,5	0,13	IP20	CE EAC	555,00
TUBES PL 90	BC/LU FU/TR	NO	E27	1x77W		DIM1	6,0	0,14	IP20	CE EAC	750,00
TUBES PL 120	BC/LU FU/TR	NO	E27	1x77W		DIM1	8,0	0,14	IP20	CE EAC	970,00
TUBES PL 9	BC/LU FU/TR	NO	E27	9x77W		DIM1	27,0	0,51	IP20	CE EAC	3.935,00
TUBES PL 15	BC/LU FU/TR	NO	E27	15x77W		DIM1	60,0	1,00	IP20	CE EAC	8.315,00

finitura vetro / glass finish | finitura struttura / frame finish

VEGA

design Michele De Lucchi 1982

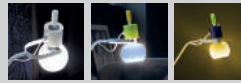

BC | MC/1 | MC/2 | BC



VEGA AP

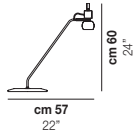

VEGA LT

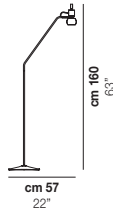

VEGA PT

codice / code	vetro / glass	struttura / frame	W	lumen @3000K	°K option	dimmer option	m³	EU cert.	International cert.	€
VEGA AP	BC MC/1 MC/2	BC	G9	1×60W		DIM1	1,0 0,04	IP20	CE EAC CCC	480,00
VEGA LT	BC MC/1 MC/2	BC	G9	1×60W		ON/OFF*	4,5 0,07	IP20	CE EAC	705,00
VEGA PT	BC MC/1 MC/2	BC	G9	1×60W		ON/OFF*	5,0 0,18	IP20	CE EAC	800,00

* Vedi nota pagina 8 / See note on page 8

finitura vetro / glass finish | finitura struttura / frame finish

WITHWHITE

design Mauro Olivieri 2009



BC/ST | BC

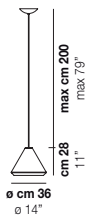

WITHWHITE SP G

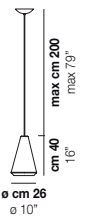

WITHWHITE SP M

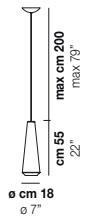

WITHWHITE SP P

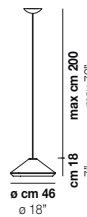

WITHWHITE SP X

codice / code	vetro / glass	struttura / frame	W	lumen @3000K	°K option	dimmer option	m³	EU cert.	International cert.	€
WITHWHITESP G	BC/ST	BC	E27	1×77W		DIM1	3,0 0,10	IP20	CE EAC CCC	345,00
WITHWHITESP M	BC/ST	BC	E27	1×77W		DIM1	4,0 0,08	IP20	CE EAC CCC	335,00
WITHWHITESP P	BC/ST	BC	E27	1×77W		DIM1	4,0 0,11	IP20	CE EAC CCC	355,00
WITHWHITESP X	BC/ST	BC	E27	1×77W		DIM1	4,0 0,13	IP20	CE EAC CCC	370,00

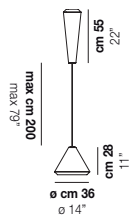

WITHWHITE SP 18 G

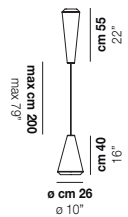

WITHWHITE SP 18 M

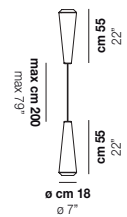

WITHWHITE SP 18 P

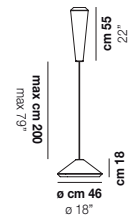

WITHWHITE SP 18 X

codice / code	vetro / glass	struttura / frame	W	lumen @3000K	°K option	dimmer option	m³	EU cert.	International cert.	€
WITHWHITESP 18 G	BC/ST	BC	E27	2×77W		DIM1	5,5 0,28	IP20	CE EAC CCC	715,00
WITHWHITESP 18 M	BC/ST	BC	E27	2×77W		DIM1	5,5 0,29	IP20	CE EAC CCC	685,00
WITHWHITESP 18 P	BC/ST	BC	E27	2×77W		DIM1	6,0 0,18	IP20	CE EAC CCC	715,00
WITHWHITESP 18 X	BC/ST	BC	E27	2×77W		DIM1	6,0 0,24	IP20	CE EAC CCC	725,00

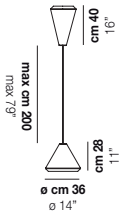

WITHWHITE SP 26 G

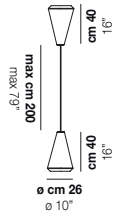

WITHWHITE SP 26 M

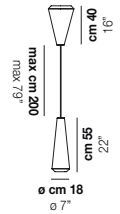

WITHWHITE SP 26 P

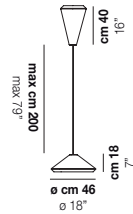

WITHWHITE SP 26 X

codice / code	vetro / glass	struttura / frame	W	lumen @3000K	°K option	dimmer option	Ⓜ	m³	EU cert.	International cert.	€	
WITHWHITESP 26 G	BC/ST	BC	E27	2x77W		DIM1	5,0	0,22	⚡ IP20	CE	ERL	675,00
WITHWHITESP 26 M	BC/ST	BC	E27	2x77W		DIM1	5,0	0,22	⚡ IP20	CE	ERL	675,00
WITHWHITESP 26 P	BC/ST	BC	E27	2x77W		DIM1	5,0	0,20	⚡ IP20	CE	ERL	685,00
WITHWHITESP 26 X	BC/ST	BC	E27	2x77W		DIM1	6,0	0,20	⚡ IP20	CE	ERL	715,00

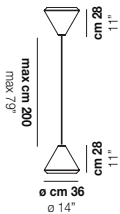

WITHWHITE SP 36 G

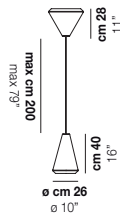

WITHWHITE SP 36 M

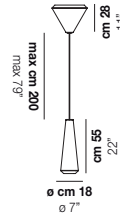

WITHWHITE SP 36 P

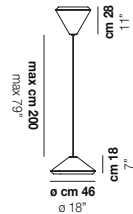

WITHWHITE SP 36 X

codice / code	vetro / glass	struttura / frame	W	lumen @3000K	°K option	dimmer option	Ⓜ	m³	EU cert.	International cert.	€	
WITHWHITESP 36 G	BC/ST	BC	E27	2x77W		DIM1	5,5	0,32	⚡ IP20	CE	ERL	715,00
WITHWHITESP 36 M	BC/ST	BC	E27	2x77W		DIM1	5,5	0,21	⚡ IP20	CE	ERL	700,00
WITHWHITESP 36 P	BC/ST	BC	E27	2x77W		DIM1	5,0	0,20	⚡ IP20	CE	ERL	725,00
WITHWHITESP 36 X	BC/ST	BC	E27	2x77W		DIM1	5,0	0,21	⚡ IP20	CE	ERL	740,00

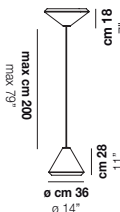

WITHWHITE SP 46 G

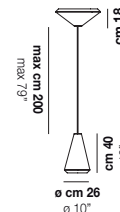

WITHWHITE SP 46 M

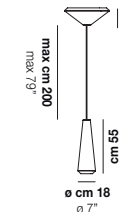

WITHWHITE SP 46 P

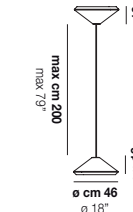

WITHWHITE SP 46 X

codice / code	vetro / glass	struttura / frame	W	lumen @3000K	°K option	dimmer option	Ⓜ	m³	EU cert.	International cert.	€	
WITHWHITESP 46 G	BC/ST	BC	E27	3x77W		DIM1	7,0	0,26	⚡ IP20	CE	ERL	780,00
WITHWHITESP 46 M	BC/ST	BC	E27	3x77W		DIM1	7,0	0,24	⚡ IP20	CE	ERL	765,00
WITHWHITESP 46 P	BC/ST	BC	E27	3x77W		DIM1	7,0	0,29	⚡ IP20	CE	ERL	790,00
WITHWHITESP 46 X	BC/ST	BC	E27	3x77W		DIM1	8,0	0,20	⚡ IP20	CE	ERL	805,00



Condizioni di vendita
Sales conditions

Condizioni di vendita Validità del presente listino dal 01.05.2023 al 31.12.2023

- 1. Condizioni di vendita personalizzate:** le seguenti condizioni di vendita sono generali. Le condizioni di vendita dettagliate e personalizzate sono pubblicate nel portale MyVistosi (www.vistosi.it/portal). Le condizioni di vendita avranno validità annuale con scadenza il 31/12, senza tacito rinnovo e salvo eventi di forza maggiore. I Clienti che non acquisteranno alcun prodotto per un periodo superiore a 12 mesi saranno considerati inattivi e tutte le condizioni di vendita personalizzate non saranno più in vigore.
- 2. Prodotti fuori standard:** in caso di ordini di prodotti fuori listino, di prodotti personalizzati o di prodotti con modifiche dallo standard, Vetreria Vistosi Srl si riserva il diritto di formulare delle offerte con condizioni di vendita diverse da quelle accordate.
- 3. Tempi di consegna e disponibilità di magazzino:** per la merce non a magazzino, i tempi di consegna medi sono di 6/7 settimane. Le disponibilità dei prodotti a magazzino vengono aggiornate quotidianamente e sono consultabili nel portale MyVistosi.
- 4. Controllo della merce alla ricezione:** il Cliente è tenuto a controllare accuratamente la merce entro 8 giorni il ricevimento della stessa e sempre prima di consegnarla o di spedirla all'utente finale. Non saranno accettati reclami per merce non presente nel luogo di destinazione indicato nei documenti di trasporto.
- 5. Danni evidenti da trasporto:** eventuali danni da trasporto alla merce o all'imballo della merce stessa, evidenti al momento della consegna, come pure differenze di quantità e/o di modello rispetto a quanto indicato nel documento di trasporto, devono essere segnalate con riserva specifica e dettagliata nella lettera di vettura del corriere.
- 6. Danni occulti da trasporto:** eventuali danni da trasporto alla merce, non evidenti al momento della consegna o non ragionevolmente presumibili al momento della consegna, devono essere segnalati entro 8 giorni dal ricevimento, nella sezione reclami del portale MyVistosi.
- 7. Caratteristiche del vetro di Murano:** le lavorazioni completamente manuali, i complessi processi di fusione, la raffinatezza delle miscele chimiche dei vetri di Vistosi, tipiche delle antiche tecniche di lavorazione del vetro di Murano, possono dar luogo a leggere imprecisioni dei colori, nelle forme e nelle dimensioni, negli spessori e nei decori. Più che imperfezioni o difformità di qualità sono da considerarsi espressione del vetro lavorato a mano e soffiato a bocca. Piccole bolle irregolari, venature, piccoli puntini di materiale denso e altre imperfezioni devono quindi essere tollerate, in particolare modo nelle forme e nelle lavorazioni più complesse o nei modelli di medio-grandi dimensioni.
- 8. Riserva di modica di prodotti:** Vetreria Vistosi Srl si riserva di modificare in qualsiasi momento e senza preavviso i propri prodotti. Il Cliente che dovesse avere delle necessità specifiche o che dovesse abbinare i modelli ordinati ad altri già in suo possesso è tenuto a specificarlo nell'ordine.
- 9. Modelli fuori produzione:** Vetreria Vistosi Srl si riserva il diritto di eliminare dalla produzione uno o più modelli senza darne preavviso. Il Cliente si impegna a segnalare tempestivamente qualsiasi progetto o quotazione, per dare modo all'Azienda di tenerne conto nella scelta dei modelli da eliminare dalla produzione.
- 10. Gestione ordini:** gli ordini saranno considerati accettati solo al momento dell'invio della conferma d'ordine via e-mail all'indirizzo indicato dal Cliente e riportato nella medesima scheda Cliente presente nel portale MyVistosi. Qualora talune caratteristiche estetiche e/o tecniche del prodotto selezionato siano vincolanti per l'acquisto del prodotto stesso, il Cliente è tenuto a rendere esplicita tale necessità in fase d'ordine con opportuna nota. (Es. necessità di abbinamento di prodotti della stessa collezione, due tonalità di vetro destinate allo stesso ambiente o dimensioni del prodotto vincolanti ad una installazione specifica).
Il Cliente si impegna altresì a richiedere modifiche alle conferme d'ordine per qualsiasi ragione entro e non oltre 2 giorni lavorativi dal ricevimento della conferma d'ordine. Trascorso questo termine gli ordini non saranno modificabili o cancellabili. Data la natura artigianale del prodotto Vetreria Vistosi Srl declina ogni responsabilità relativa ad eventuali costi e/o danni derivanti dai ritardi di consegna. Il cliente ha il diritto all'annullamento dell'ordine relativo ai modelli acquistati qualora il ritardo della consegna di questi ultimi dovesse superare i sei mesi dalla data indicata nella conferma d'ordine.
- 11. Aggiunte ordine:** le aggiunte d'ordine che, per mancanza di disponibilità di magazzino, restassero inevase, verranno considerate come ordini a sé stanti.
- 12. Spedizioni parziali:** spedizioni parziali di ordini su sollecito del cliente, verranno considerate come ordini a sé stanti.
- 13. Garanzia:** tutti i modelli sono garantiti per un periodo di 2 anni dalla data del documento di vendita di Vetreria Vistosi Srl.
- 14. Esclusioni:** i prezzi indicati in questo listino non sono comprensivi di IVA, imballi speciali, pallet, lampadine e tutto quanto non espressamente indicato.
- 15. Resa della merce:** Franco Fabbrica. Salvo diversi accordi pubblicati nell'area riservata del sito aziendale www.vistosi.it/portal.
- 16. Foro competente:** per ogni eventuale controversia di qualsiasi genere e sorta in qualsiasi luogo sarà competente il foro di Venezia e la legge applicabile sarà quella Italiana.

Sales conditions Validity of this price list from 01.05.2023 to 31.12.2023

- 1. Personalized conditions of sales:** the following are General conditions of sale. The detailed and personalized conditions of sale are published in the MyVistosi portal (www.vistosi.it/portal). The conditions of sale will be valid for one year expiring on 31/12, without tacit renewal and except in the event of force majeure. Customers who do not purchase any products for a period exceeding 12 months will be considered inactive and all personalized sales conditions will no longer be in force.
- 2. Non-standard products:** in the case of orders for products that are not listed in the price list, customized products or products with modifications from the standard, Vetreria Vistosi Srl reserves the right to make offers with conditions of sale different from those agreed.
- 3. Delivery times and stock availability:** for goods not in stock, the average delivery times are 6/7 weeks. The availability of products in stock is updated daily and can be viewed on the MyVistosi portal.
- 4. Inspection of goods upon receipt:** the Customer shall carefully check the goods within 8 days of receipt and always before delivering or sending them to the end user. Complaints will not be accepted for goods not available at the place of destination indicated in the transport documents.
- 5. Any damage to goods caused during transport:** any transport damage to goods or to the packaging of goods, evident at the time of delivery, as well as differences in quantity and / or model compared to what is indicated in the transport document, must be reported with specific and detailed reservation in the courier waybill.
- 6. Hidden damage during transport:** any transport damage to goods, not evident at the time of delivery or not reasonably foreseeable at the time of delivery, must be reported within 8 days from the delivery, in the complaints section of the MyVistosi portal.
- 7. Characteristics of Murano glass:** the completely manual processing, the complex melting processes, the refinement of the chemical mixtures of Vistosi glass, typical of the ancient processing techniques of Murano glass, can give rise to slight inaccuracies in the colors, in the shapes and sizes, thicknesses and decorations. Rather than imperfections or quality differences, they must be considered an expression of hand-worked and mouth-blown glass processing. Small irregular bubbles, veins, small dots of dense material and other imperfections must therefore be tolerated, especially in the more complex shapes and processes or in medium-large models.
- 8. Product modification reserve:** Vetreria Vistosi Srl reserves the right to modify its products at any time and without notice. The customer who has specific needs or who should combine the models ordered with others already in his possession must specify this in the order.
- 9. Discontinued models:** Vetreria Vistosi Srl reserves the right to remove one or more models from production without giving prior notice. The Customer agree to promptly report any project or quotation in order to allow the Company to take them into account in the choice of models to be removed from production and discontinued.
- 10. Order management:** orders will be considered accepted only when the order confirmation is sent by e-mail to the address indicated by the Customer and reported in the Customer data sheet in the MyVistosi portal. If certain aesthetic and/or technical characteristics of the selected product are binding for the purchase of the product itself, the Customer is obliged to make this explicit in the order phase with an appropriate note. (E.g. the need to combine products from the same collection, two shades of glass intended for the same environment or product dimensions that are binding for a specific installation). The Customer also undertakes to request changes to order confirmations for any reason within and no later than 2 working days from receipt of the order confirmation. After this term, orders shall not be modifiable or cancellable. Given the handcrafted nature of the product Vetreria Vistosi Srl declines all responsibility for any costs and/or damages deriving from delays in delivery. The customer shall have the right to cancel the order relating to the models purchased if the delay in delivery of the latter exceeds six months from the date indicated in the order confirmation.
- 11. Additions to orders:** additions to orders that, due to lack of stock availability, remain unfulfilled, will be considered as separate orders.

12. **Partial shipments:** partial shipments of orders upon customer reminder will be considered as separate orders.
13. **Warranty:** all models are guaranteed for a period of 2 years from the date of the Vetzeria Vistosi Srl sales document.
14. **Exclusions:** the prices indicated in this price list do not include VAT, special packaging, pallets, light bulbs and all when not expressly indicated.
15. **Return of goods:** Ex Works. Unless otherwise agreed, published in the reserved area of the company website www.vistosi.it/portal.
16. **Jurisdiction:** for any dispute of any kind and arising in any place the court of Venice will be competent and the applicable law will be the Italian one.

Verkaufsbedingungen Gültigkeit dieser Preisliste vom 01.05.2023 bis 31.12.2023

1. **Kundenspezifische Verkaufsbedingungen:** Die folgenden Verkaufsbedingungen sind allgemein. Die detaillierten und individuellen Verkaufsbedingungen werden auf dem MyVistosi-Portal (www.vistosi.it/portal) veröffentlicht. Die Verkaufsbedingungen gelten für ein Jahr bis zum 31.12. und können nicht stillschweigend verlängert werden, es sei denn, es liegt ein Fall höherer Gewalt vor. Kunden, die über einen Zeitraum von mehr als 12 Monaten kein Produkt kaufen, gelten als inaktiv und alle personalisierten Verkaufsbedingungen gelten nicht mehr.
2. **Nicht standardisierte Produkte:** Bei Bestellungen von nicht gelisteten Produkten, kundenspezifischen Produkten oder Produkten, die vom Standard abweichen, behält sich Vetzeria Vistosi Srl das Recht vor, Angebote mit anderen als den vereinbarten Verkaufsbedingungen abzugeben.
3. **Lieferzeiten und Lagerverfügbarkeit:** Für Waren, die nicht auf Lager sind, beträgt die durchschnittliche Lieferzeit 6/7 Wochen. Die Verfügbarkeit der vorrätigen Produkte wird täglich aktualisiert und kann auf dem Portal MyVistosi eingesehen werden.
4. **Kontrolle der Ware nach deren Erhalt:** Der Kunde ist verpflichtet, die Ware innerhalb von 8 Tagen nach Erhalt und stets vor der Lieferung oder dem Versand an den Endverbraucher, sorgfältig zu kontrollieren.
5. **Offensichtliche Transportschäden:** Transportschäden an der Ware oder an der Verpackung der Ware selbst, die zum Zeitpunkt der Lieferung erkennbar sind, sowie Unterschiede in Menge und / oder Modellen im Vergleich zu den Angaben im Transportdokument sind mit spezifischem und detailliertem Vorbehalt im Kurier-Frachtbrief zu melden.
6. **Versteckte Schäden während des Transportes:** Transportschäden an der Ware, die zum Zeitpunkt der Lieferung nicht erkennbar oder zum Zeitpunkt der Lieferung nicht vermutbar sind, müssen innerhalb von 8 Tagen nach Erhalt in der Sektion "Beschwerden" des MyVistosi-Portals gemeldet werden.
7. **Eigenschaften des Murano-Glases:** Die vollkommen manuelle Verarbeitung, die komplexen Schmelzprozesse und die Vereinheiten der chemischen Gemische des Vistosi-Glases, welche für die antiken Techniken der Murano-Glasverarbeitung typisch sind, können leichte Ungenauigkeiten in den Farben, Formen und Größen, Stärken und Dekorationen aufweisen. Sie sind mehr als Unvollkommenheiten oder Qualitätsunterschiede, sie sind Ausdruck von handgefertigtem und mundgeblasenem Glas. Kleine unregelmäßige Blasen, Venen, kleine Punkte aus dichtem Material und andere Unvollkommenheiten müssen daher toleriert werden, insbesondere bei komplexeren Formen und Prozessen oder bei mittelgroßen Modellen.
8. **Produktänderungsreserve:** Vetzeria Vistosi Srl behält sich das Recht vor, seine Produkte jederzeit und ohne vorherige Ankündigung zu ändern. Der Kunde, der spezielle Bedürfnisse hat oder die bestellten Modelle mit anderen in seinem Besitz befindlichen kombinieren will, muss dies in der Bestellung angeben.
9. **Auslaufmodelle:** Vetzeria Vistosi Srl behält sich das Recht vor, ein oder mehrere Modelle ohne vorherige Ankündigung aus der Produktion zu nehmen. Der Kunde verpflichtet sich, jedes Projekt oder Angebot unverzüglich zu melden, damit das Unternehmen diese bei der Auswahl der Modelle, die aus der Produktion ausgeschlossen werden, berücksichtigen kann.
10. **Auftragsverwaltung:** Bestellungen gelten erst dann als angenommen, wenn die Auftragsbestätigung per E-Mail an die vom Kunden angegebene und im Kundenbereich im Portal MyVistosi vermerkte Adresse übermittelt wurde. Wenn bestimmte ästhetische und/oder technische Merkmale des ausgewählten Produkts für den Kauf des Produkts selbst verbindlich sind, ist der Kunde verpflichtet, dies in der Bestellphase mit einem entsprechenden Vermerk ausdrücklich anzugeben. (z. B. die Notwendigkeit, Produkte aus derselben Kollektion zu kombinieren, zwei Glastöne, die für dieselbe Umgebung bestimmt sind, oder Produktabmessungen, die für eine bestimmte Installation verbindlich sind). Der Kunde verpflichtet sich außerdem, Änderungen der Auftragsbestätigungen aus beliebigen Gründen innerhalb von 2 Arbeitstagen nach Erhalt der Auftragsbestätigung zu beantragen. Nach Ablauf dieser Frist können die Bestellungen nicht mehr geändert oder storniert werden. In Anbetracht des handwerklichen Charakters des Produkts lehnt Vetzeria Vistosi Srl jede Verantwortung für Kosten und/oder Schäden ab, die sich aus Lieferverzögerungen ergeben. Der Kunde hat das Recht, die Bestellung der gekauften Modelle zu stornieren, wenn der Lieferverzug bei diesen Modellen mehr als sechs Monate ab dem in der Auftragsbestätigung angegebenen Datum beträgt.
11. **Auftragsweiterungen:** Auftragsweiterungen, die aufgrund mangelnder Lagerverfügbarkeit nicht erfüllt werden, gelten als separate Bestellungen.
12. **Teillieferungen:** die vom Kunden gewünschten Teillieferungen von Bestellungen gelten als separate Bestellungen.
13. **Garantie:** Für alle Modelle gilt, ab dem Datum des Verkaufsbelegs von Vetzeria Vistosi Srl, eine Garantie von 2 Jahren
14. **Ausschlüsse:** Die in dieser Preisliste angegebenen Preise enthalten keine Mehrwertsteuer, Sonderverpackungen, Paletten, Glühbirnen und anderes, wenn nicht ausdrücklich angegeben.
15. **Warenlieferung:** Ab Werk. Sofern nicht anders vereinbart und im reservierten Bereich des Firmenportals "MyVistosi" www.vistosi.it/portal veröffentlicht.
16. **Gerichtsstand:** Für alle Streitigkeiten, egal welcher Art sie sind und an welchem Ort sie auftreten, ist das Gericht Venedig zuständig. Es gilt italienisches Recht

Conditions de vente Validité de cette liste de prix du 01.05.2023 au 31.12.2023

1. **Conditions de vente personnalisées:** les conditions de vente suivantes sont générales. Les conditions de vente détaillées et personnalisées sont publiées sur le portail MyVistosi (www.vistosi.it/portal). Les conditions de vente sont valables pour une année expirant le 31/12, sans tacite reconduction et sauf cas de force majeure. Les clients qui n'achètent aucun produit pendant une période supérieure à 12 mois seront considérés comme inactifs et toutes les conditions de vente personnalisées ne seront plus en vigueur.
2. **Produits non standard:** en cas de commande de produits sans prix, de produits personnalisés ou de produits avec des modifications par rapport à la norme, Vetzeria Vistosi Srl se réserve le droit de faire des offres avec des conditions de vente différentes de celles convenues.
3. **Délais de livraison et disponibilité des stocks:** pour les produits qui ne sont pas en stock, les délais moyens de livraison sont de 6/7 semaines. La disponibilité des produits en stock est mise à jour quotidiennement et peut être consultée sur le portail MyVistosi
4. **Contrôle des marchandises à la réception:** le client doit contrôler soigneusement la marchandise dans les 8 jours suivant sa réception et toujours avant de la livrer ou de l'envoyer à l'utilisateur final. Les réclamations ne seront pas acceptées pour les marchandises qui ne se trouvent pas au lieu de destination indiqué dans les documents de transport.
5. **Dommages de transport manifestes:** tout dommage de transport aux marchandises ou à l'emballage des marchandises elles-mêmes, évident au moment de la livraison, ainsi que les différences de quantité et / ou de modèle par rapport à ce qui est indiqué dans le document de transport, doivent être signalés sous réserve spécifique et détaillée dans la lettre de transport.
6. **Dommages cachés pendant le transport:** tout dommage de transport à la marchandise, qui ne soit pas évident au moment de la livraison ou qui ne soit pas raisonnablement prévisible au moment de la livraison, doit être signalé dans les 8 jours suivants la réception, dans la section des réclamations du portail MyVistosi.
7. **Caractéristiques du verre de Murano:** le traitement entièrement manuel, le processus de fusion complexes, le raffinement des mélanges chimiques du verre Vistosi, types des anciennes techniques de traitement du verre de Murano, peuvent donner lieu à de légères (inexactitudes) variations dans les couleurs, dans les formes et dimensions, épaisseurs et décorations. Plutôt que des imperfections ou des différences de qualité, ils doivent être considérés comme une expression du verre travaillé à la main et soufflé à la bouche. Les petites bulles irrégulières, les veines, les petits points de matière dense et autres imperfections doivent donc être tolérés, en particulier dans les formes et procédés les plus complexes ou dans les modèles de taille moyenne et grande.

8. **Réserve de modification des produits:** Vetreria Vistosi Srl se réserve le droit de modifier ses produits à tout moment et sans préavis. Le Client qui a des besoins spécifiques ou qui doit combiner les modèles commandés avec d'autres déjà en sa possession est tenu de le préciser dans la commande.
9. **Modèles abandonnés:** Vetreria Vistosi Srl se réserve le droit de retirer un ou plusieurs modèles de la production sans préavis. Le Client s'engage à signaler dans les meilleurs délais tout projet ou devis, pour permettre à la Société de les tenir en compte lors du choix des modèles à éliminer de la production.
10. **Gestion des commandes:** les commandes ne seront considérées comme acceptées que lorsque la confirmation de commande est envoyée par e-mail à l'adresse indiquée par le Client et mentionnée dans le même onglet Client sur le portail MyVistosi. Si certaines caractéristiques esthétiques et/ou techniques du produit sélectionné sont contraignantes pour l'achat du produit lui-même, le Client est tenu de l'expliciter en phase de commande par une note appropriée. (Par exemple, la nécessité de combiner des produits d'une même collection, deux teintes de verre destinées au même environnement ou des dimensions de produits contraignantes pour une installation spécifique). Le Client s'engage également à demander des modifications des confirmations de commande pour quelque raison que ce soit dans un délai de 2 jours ouvrables à compter de la réception de la confirmation de commande et au plus tard dans ce délai. Passé ce délai, les commandes ne sont plus modifiables ni annulables. Compte tenu de la nature artisanale du produit, Vetreria Vistosi Srl décline toute responsabilité pour les coûts et/ou dommages éventuels découlant des retards de livraison. Le client a le droit d'annuler la commande relative aux modèles achetés si le retard de livraison de ces derniers dépasse six mois à compter de la date indiquée dans la confirmation de la commande.
11. **Ajout de commandes:** les ajouts de commandes qui, en raison d'un manque de stock disponible, ne sont pas exécutés, seront considérés comme des commandes distinctes.
12. **Envois partiels:** les envois partiels de commandes sur sollicitation du client seront considérés comme des commandes séparées.
13. **Garantie:** tous les modèles sont garantis pour une période de 2 ans à compter de la date du document de vente Vetreria Vistosi Srl.
14. **Exclusions:** les prix indiqués dans cette liste de prix ne comprennent pas la TVA, les emballages spéciaux, les palettes, les ampoules et l'ensemble lorsqu'ils ne sont pas expressément indiqués.
15. **livraisons:** départ usine. Sauf accord contraire, publié dans la zone réservée du site Web « MyVistosi » de la société www.vistosi.it/portal.
16. **Jurisdiction:** pour tout litige de quelque nature qu'il s'agisse et survenant en tout lieu, le tribunal de Venise sera compétent et la loi applicable sera la loi italienne.

Condiciones de venta Validez de esta lista de precios desde el 01.05.2023 hasta el 31.12.2023

1. **Condiciones de venta personalizadas:** las siguientes condiciones de venta son generales. Las condiciones de venta detalladas y personalizadas se publican en el portal MyVistosi (www.vistosi.it/portal). Las condiciones de venta tienen una validez de un año que expira el 31/12, sin renovación tácita y salvo en caso de fuerza mayor. Los clientes que no adquieran ningún producto por un período superior a 12 meses serán considerados inactivos y todas las condiciones de venta personalizadas perderán validez.
2. **Productos no estándar:** en el caso de pedidos de productos no incluidos en el catálogo-tarifa, productos personalizados o productos con cambios respecto al estándar, Vetreria Vistosi Srl se reserva el derecho de realizar ofertas con condiciones de venta diferentes a las acordadas.
3. **Plazos de entrega y disponibilidad de stock:** para las mercancías fuera de stock, el plazo medio de entrega es de 6/7 semanas. La disponibilidad de los productos en stock se actualiza diariamente y puede consultarse en el portal MyVistosi.
4. **Inspección de la mercancía al recibirla:** el Cliente deberá comprobar cuidadosamente la mercancía en los 8 días siguientes a su recepción y siempre antes de entregarla o enviarla al usuario final. No se aceptarán reclamaciones por mercancías que no estén presentes en el lugar de destino indicado en los documentos de transporte.
5. **Daños de transporte evidentes:** cualquier daño de transporte de la mercancía o del embalaje de la misma, evidente en el momento de la entrega, así como las diferencias en cantidad y / o modelo con respecto a lo indicado en el documento de transporte, deberán ser comunicados con reserva específica y detallada en la carta de porte del transportista.
6. **Daños ocultos durante el transporte:** cualquier daño de transporte de la mercancía, no evidente en el momento de la entrega o no razonablemente presumible en el momento de la entrega, debe ser comunicado dentro de los 8 días de la entrega, en la sección de quejas del portal MyVistosi.
7. **Características del vidrio de Murano:** la elaboración completamente manual, los complejos procesos de fusión, el refinamiento de las mezclas químicas del vidrio de Vistosi, típico de las antiguas técnicas de elaboración del vidrio de Murano, pueden dar lugar a ligeras imprecisiones en los colores, en el formas y tamaños, espesores y decoraciones. Más que imperfecciones o diferencias de calidad, deben considerarse como la expresión de vidrio hecho a mano y soplado a boca. Por lo tanto, deben tolerarse pequeñas burbujas irregulares, venas, pequeños puntos de material denso y otras imperfecciones, especialmente en las formas y procesos más complejos o en modelos medio-grandes.
8. **Reserva de modificación de productos:** Vetreria Vistosi Srl se reserva el derecho de modificar sus productos en cualquier momento y sin previo aviso. El cliente que tenga necesidades específicas o que tenga que combinar los modelos pedidos con otros que ya en su poder, debe especificarlo en el pedido.
9. **Modelos descatalogados:** Vetreria Vistosi Srl se reserva el derecho de retirar uno o más modelos de la producción sin previo aviso. El Cliente se compromete a comunicar con prontitud cualquier proyecto o presupuesto a procesar, para que Vistosi los tenga en cuenta a la hora de elegir los modelos a eliminar de la producción.
10. **Gestión de pedidos:** los pedidos se considerarán aceptados únicamente cuando la confirmación del pedido se envíe por correo electrónico a la dirección indicada por el Cliente e indicada en la página del Cliente en el portal MyVistosi. Si determinadas características estéticas y/o técnicas del producto seleccionado son vinculantes para la compra del propio producto, el Cliente está obligado a explicitarlo en la fase de pedido con una nota adecuada. (Por ejemplo, la necesidad de combinar productos de la misma colección, dos tonos de vidrio destinados al mismo entorno o las dimensiones del producto que son vinculantes para una instalación específica). El Cliente también se compromete a solicitar cambios en las confirmaciones de pedido por cualquier motivo en un plazo máximo de 2 días laborables desde la recepción de la confirmación del pedido. Después de este plazo, los pedidos no serán modificables ni anulables. Dado el carácter artesanal del producto, Vetreria Vistosi Srl declina toda responsabilidad por los costes y/o daños derivados de los retrasos en la entrega. El cliente tendrá derecho a anular el pedido relativo a los modelos adquiridos si el retraso en la entrega de éstos supera los seis meses desde la fecha indicada en la confirmación del pedido.
11. **Adiciones a los pedidos:** las adiciones a los pedidos que, por falta de disponibilidad en el almacén, no se hayan cumplido, se considerarán como pedidos separados del anterior.
12. **Envíos parciales:** los envíos parciales de pedidos a petición del cliente se considerarán como pedidos separados.
13. **Garantía:** todos los modelos están garantizados por un período de 2 años a partir de la fecha del documento de venta de Vetreria Vistosi Srl.
14. **Exclusiones:** los precios indicados en esta lista de precios no incluyen IVA, embalajes especiales, paletas, bombillas y todo cuando no se indique expresamente.
15. **Devolución de mercancías:** Ex Works. Salvo acuerdo en contrario, publicado en el área reservada del sitio web de la empresa www.vistosi.it/portal.
16. **Jurisdicción:** para cualquier disputa de cualquier tipo y que surja en cualquier lugar será competente el tribunal de Venecia y la ley aplicable será la italiana.

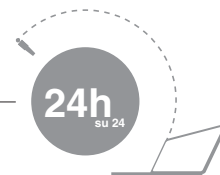

MyVistosi è la piattaforma informatica riservata ai rivenditori **Vistosi** che consente di verificare la disponibilità dei prodotti in tempo reale, inserire un ordine, controllare la situazione della spedizione e molto altro.

Questi i vantaggi:

- Sistema aggiornato in tempo reale, l'azienda ti apre le porte!
- Accesso consentito h 24, tutto l'anno.
- Informazioni dettagliate su: situazione ordini, stato fatture e documenti di trasporto, tracciabilità dei plichi attraverso i sistemi on line delle società di spedizione.
- Risposte veloci e personalizzate a: domande generiche, suggerimenti, reclami.
- Agevolazione della contabilità grazie alla possibilità di scaricare i dati in formato Excel e ottenere copie in formato pdf delle fatture e dei documenti di trasporto.
- Interfaccia per inviare Ordini online.
- Scelta dei prodotti sull'intero catalogo, compresi i ricambi dei vetri, con un sistema di ricerca attraverso le immagini, senza bisogno di conoscere i codici dei modelli.
- Conferme d'ordine in formato pdf con immagini e disegni dimensionali dei modelli e informazioni delle disponibilità e tempi di consegna, monitorati costantemente!
- Preventivi su prodotti personalizzati grazie al servizio articoli speciali.
- Informazioni continue attraverso un sistema di notifiche e avvisi via e-mail o sms.
- Servizio di collegamento in tempo reale ftp. Il sistema consente di scaricare tutte le informazioni grafiche e testuali, con format definiti, per facilitare la costruzione dello stesso direttamente nel sito del rivenditore.

Come richiedere l'accesso:

Per usufruire dei servizi di **MyVistosi** è sufficiente richiedere username e password all'agente di zona o inviare un'email al seguente indirizzo: **helpweb@vistosi.it**

MyVistosi is the IT platform reserved for **Vistosi** dealers that allows you to check the availability of products in real time, place an order, check the shipping situation and much more.

These are the advantages:

- System updated in real time, the company opens its doors to you!
- Access is possible around the clock all year round.
- Detailed information on: order status, invoices and transport documents, traceability of parcels via the transport companies' online systems.
- Quick and personalized answers to: general questions, suggestions, complaints.
- Facilitation for accounting thanks to the possibility of downloading data in excel format and receiving copies of invoices and transport documents in PDF format.
- Interface for sending online orders.
- Selection of products from the entire catalog, including glass spare parts, with an image search system without knowing the model codes.
- Order confirmations in PDF format with pictures and dimensional drawings of the models as well as information on availability and delivery times, always kept up to date.
- Offers for customized products thanks to the "Demand for Special Articles" service.
- Continuous information through a system of notifications and communications by e-mail or SMS.
- Real-time FTP link service. With this system you can download all graphic and text information in defined formats to facilitate their creation directly on the retailer's website.

How to request access to "MyVistosi":

Simply request a username and password from the area agent or send an email to the following address: **helpweb@vistosi.it**

Resta aggiornato seguendoci su / Stay up to date by following us on: **www.vistosi.it/com**

assistenza.clienti@vistosi.it
customerservice@vistosi.it
marketing@vistosi.it

servizio clienti italia / customer service from Italy
servizio clienti estero / international customer service
marketing & communication

@vetrieravistosi



@vistosi



@vetrieravistosi



@vistosi_lighting



@vistosi



@VetrieriaVistosi



Listino prezzi Euro/ Price List Euro

Edizione n° 1 - Aprile 2023
Listino 2023-1 Euro - rev 02

© Copyright - Vetreria Vistosi s.r.l.

Proprietà artistica e letteraria
riservata in tutto il mondo.

È vietata la riproduzione, anche parziale,
dei testi, dei disegni, delle immagini e qualsiasi
contenuto in genere senza autorizzazione.

Artistic and literary property reserved
worldwide. Reproduction, even partial, of texts,
drawings, images and any content in general is
prohibited without permission.



UNI EN ISO 9001 - CERTIFIED COMPANY

Vetreria Vistosi s.r.l.

Via Galileo Galilei, 9-9/A-11
31021 Mogliano Veneto - Treviso (Italy)
Tel +39 041 5903480 · +39 041 5900170
Fax +39 041 5900992 · +39 041 5904540

