

# SHOWCASE

MASIERO



# SHOWCASE

MASIERO



# Collections

Dimore 6

Atelier 96

Giardini 132

Index 3

# Una storia di luce e bellezza

IT Le collezioni Masiero esprimono un perfetto equilibrio tra il know-how tecnico e l'estetica sofisticata, spaziando da prodotti classici ad articoli contemporanei, per interni e per esterni.

EN The Masiero collections express a perfect balance between technical know-how and sophisticated aesthetics, ranging from classic products to contemporary items, for interiors and exteriors.

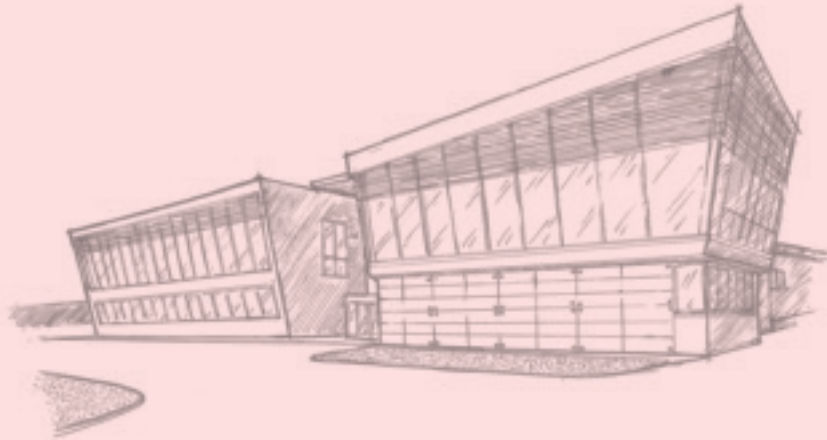

# Made in Italy

IT Manifattura Made in Italy, materiali di alta qualità, capacità tecnica di sviluppare soluzioni su misura, la passione per il design: sono questi gli elementi che rendono Masiero unica. Con oltre quarant'anni di storia di imprenditoria familiare, Masiero produce articoli di illuminazione decorativa di alta gamma. Ogni prodotto prende vita all'interno dello stabilimento di Casale Sul Sile - Treviso.

EN Manufacturing Made in Italy, high quality materials, technical ability to develop customized solutions, the passion for design: these are the elements that combined together make Masiero unique. With over forty years of family business history, Masiero produces high-end decorative lighting items. Each product comes to life within the Casale Sul Sile - Treviso plant.

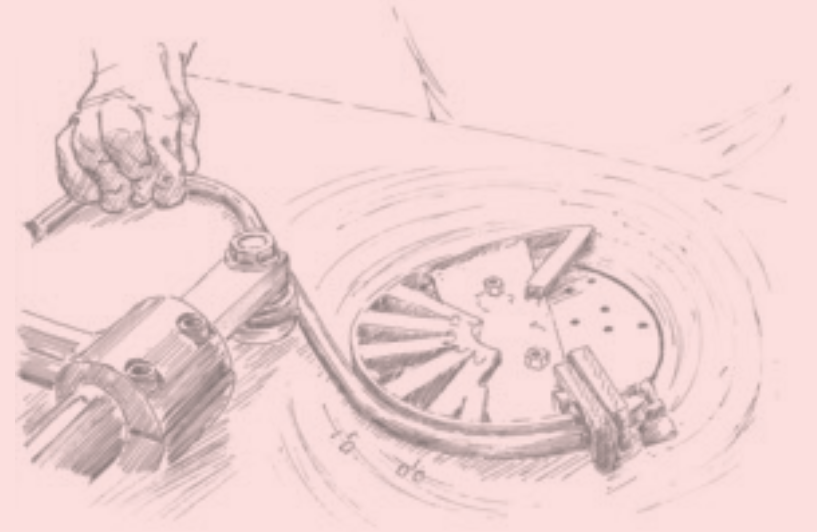

# Dimore

IT Ogni modello Dimore ha una storia differente e un carattere unico. Nasce da un'intuizione creativa che si evolve in un'idea di luce, per tradursi in uno spazio illuminato. E' un viaggio di pura passione, dove la luce incontra la materia, il metallo si unisce al vetro, ai cristalli e la tradizione sorride al futuro.

EN Each Dimore model has a different story and a unique character, born from a creative intuition that evolves into an idea of light to become an illuminated space. It is a journey of pure passion, where light meets matter, metal combines with glass and crystals and tradition smiles at the future.

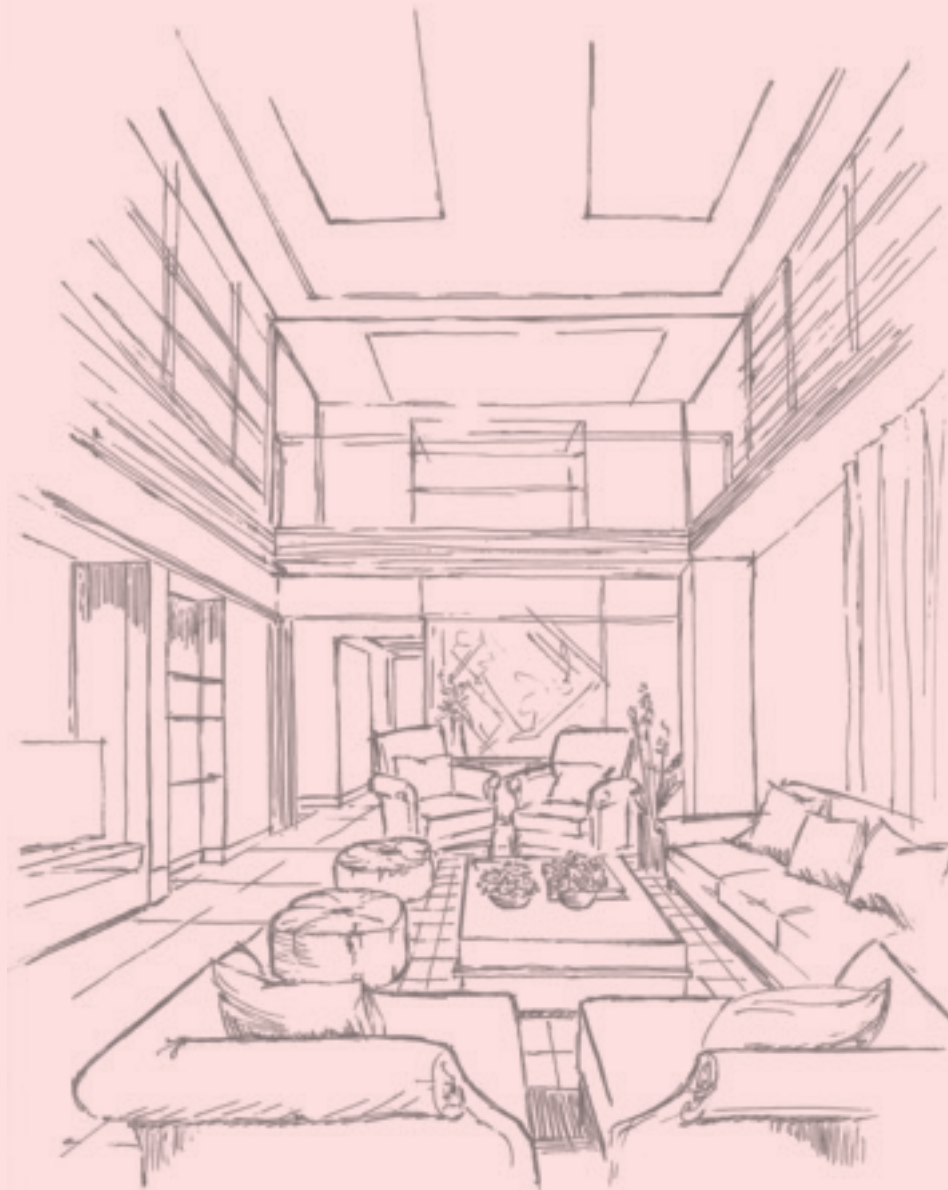

# Visio

IT Un echeggiare di richiami al mondo surrealista, strati di significato da scoprire a uno a uno nelle tante diverse configurazioni possibili delle geometrie facciali di Visio, un inno all'apparato iconografico e all'espressività del volto. Un vocabolario estetico, quello di Visio, in cui l'unione di misticismo e geometria creano variazioni imprevedibili sul tema dell'immaginazione.

EN An echo of allusions to the Surrealist world, layers of meaning to be discovered one by one in the many different possible configurations of Visio's facial geometries, an homage to the iconographic apparatus and expressiveness of the face. An aesthetic vocabulary, one of Visio, where the union of mysticism and geometry creates unpredictable variations on the theme of imagination.

DESIGN BY  
NAVA + AROSIO

SUSPENSION  
APPLIQUE  
TABLE LAMP  
FLOOR LAMP









# Cordea

IT Cordea nasce dal desiderio di reinterpretare la classica lampada industriale a testa lamellare in alluminio, in chiave contemporanea sotto il punto di vista estetico e materico. Il telaio in metallo sapientemente forgiato è caratterizzato da un cinturino in cuoio a contrasto.

EN Cordea was born out of the desire to reinterpret the classic industrial lamp with an aluminium lamellar head in a contemporary way, from an aesthetic and material perspective. The expertly forged metal frame features a contrasting leather strap.

DESIGN BY  
FAVARETTO/PARTNERS  
SUSPENSION





CORDEA S  
COMPOSITION



CORDEA  
C5 RD 80



# Tee

IT Tee è un esercizio progettuale di ricerca tra rigore geometrico ed eleganza, contrassegnato esteticamente dalla linea curva. Sfere luminose animate da linee che richiamano la natura ondulatoria della luce e raccordate su steli curvati a foggia organica, ricordano la delicatezza del fiore di calla.

EN Tee is an exploratory design exercise which balances rigour and elegance, aesthetically distinguished by its curved form. Light spheres are brought to life by contours that reflect the undulating nature of light, connected on organically shaped stems, reminiscent of the gracefulness of the calla lily flower.

DESIGN BY  
VALERIO COMETTI  
+V12DESIGN

SUSPENSION  
CEILING  
APPLIQUE  
TABLE LAMP  
FLOOR LAMP

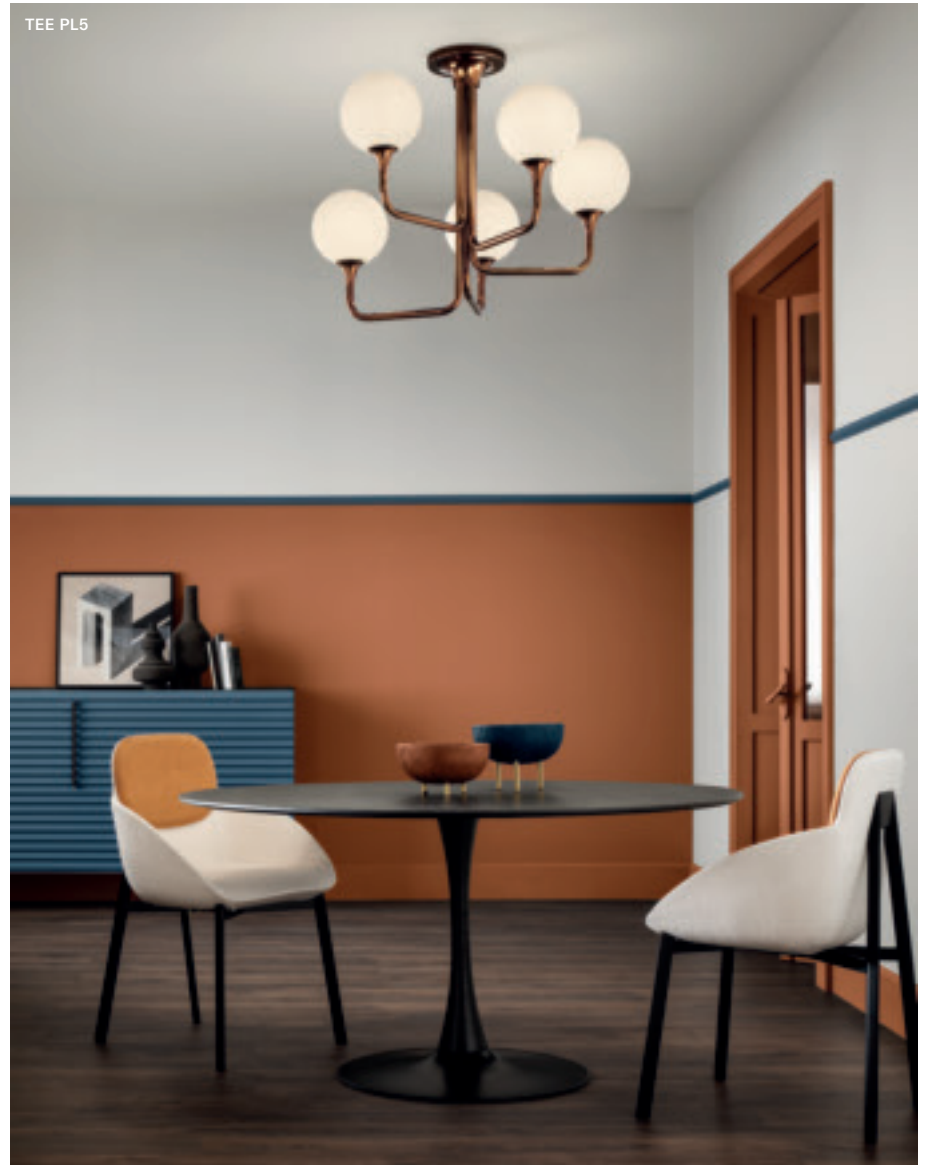

TEE PL5



TEE STL3



TEE PL 5+5 RD 120



# Ebe

IT Ebe è ispirata all'eleganza mitologica delle statue del Canova. Metallo, marmo e una rete di maglia in filo di ottone intergiscono tra di loro creando geometrie luminose di una bellezza austera, senza tempo.

EN Ebe is inspired by the mythological elegance of Canova's statues. Metal, marble and a brass wire mesh are intertwined to create luminous geometries of timeless, austere beauty.

DESIGN BY  
NICOLA GALLIZIA

APPLIQUE  
TABLE LAMP  
FLOOR LAMP



EBE A  
EBE STL  
EBE TL





EBE TL



EBE STL



# Posy

IT Equilibrio e semplicità sono le parole chiave di Posy. Sfera e stelo interagiscono tra di loro fino a trovare un equilibrio naturale che crea stupore per la naturale bellezza.

EN Balance and simplicity are the keywords of Posy. The sphere and stem interact with each other to achieve a natural balance that amazes for its natural beauty.

DESIGN BY  
SARA MORONI

SUSPENSION  
APPLIQUE  
TABLE LAMP  
FLOOR LAMP





POSY TL



POSY S5



# Iglù

IT Iglù è un'intuizione che nasce osservando la perfezione dell'elemento sfera, che diventa una forma perfetta, riconoscibile ed unica grazie ad una rete che non trattiene la luce ma crea un disegno di luci e ombre, trasformando il metallo in un gioiello luminoso.

EN Iglù is an intuition born from observing the perfection of the sphere, transformed into a perfect, recognisable and unique shape by mesh that, rather than obstruct the light, instead creates a pattern of light and shadow, transforming the metal into a luminous jewel.

DESIGN BY  
ORIANO FAVARETTO

SUSPENSION  
CEILING  
APPLIQUE  
TABLE LAMP  
FLOOR LAMP





IGLÙ PL13  
IGLÙ PL18  
IGLÙ PL25



IGLÙ S7

IGLÙ A1



IGLÙ STL1



# Horo

IT Horo trae ispirazione dalla forma del cerchio nelle sue infinite espressioni come il sole, disco di luce e simbolo universalmente noto e antico quanto il mondo. Horo è una collezione minimal, semplice, una 'forma grafica' che assume un mood vintage grazie alle particolari finiture di metallo e vetro.

EN Horo is inspired by the shape of a circle in all its infinite expressions such as the sun, a disc of light and a universally recognised symbol, as old as the world itself. Horo is a simple, minimal collection, a "graphic form" given a vintage mood by the special metal and glass finishes.



"As Awarded by The Chicago Athenaeum: Museum of Architecture and Design"

DESIGN BY  
PIERRE GONALONS

SUSPENSION  
APPLIQUE  
TABLE LAMP  
FLOOR LAMP





HORO TL



HORO STL



HORO S3



HORO C5 LN 175



# Vegas

π Vegas è liberamente ispirata all'architettura della città che non dorme mai, Las Vegas. Le iconiche luci Art Decò dallo stile classico e geometrico sono reinterpretate in chiave contemporanea, accostando vetro e metallo utilizzando le più moderne tecniche di lavorazione.

π Vegas is loosely inspired by the architecture of Las Vegas, the city that never sleeps. With their classic geometric style, the iconic Art Deco lights are reinterpreted in a contemporary key, combining glass and metal using the most modern manufacturing techniques.

DESIGN BY  
MARC SADLER

SUSPENSION  
APPLIQUE  
TABLE LAMP  
FLOOR LAMP





VEGAS BIL 180



VEGAS S OV 120



# Honicé

IT Honicé si ispira alla bellezza e maestosità di una delle pietre più antiche del mondo: l'onice. Secondo la leggenda l'onice sarebbe stata creata quando Cupido tagliò le unghie a Venere. Poichè le parti di una creatura divina non sono mortali, le divinità le trasformarono in una gemma, l'Onice. C'è della magia in lei, una pelle sottile, trasparente pur se di pietra. Honicé rende luminosa e leggera la solidità del marmo.

EN Honicé is inspired by the beauty and majesty of onyx, one of the oldest stones in the world. Legend has it that onyx was created when Cupid cut Venus' nails. Since the parts of a divine being cannot be mortal, the gods transformed them into a gemstone, onyx. It has something magical about it, a thin skin of stone, but transparent. Honicé brings brightness and luminosity to the solidity of marble.

DESIGN BY  
ORIANO FAVARETTO

SUSPENSION  
APPLIQUE  
TABLE LAMP  
FLOOR LAMP



HONICÉ A37



HONICÉ TL



HONICÉ STL



HONICÉ S80





# Nappe

IT La collezione Nappe è espressione del legame dell'azienda con il territorio. Ispirata alle nappine, ornamento tipico dei salotti veneziani del passato, utilizzate per chiudere le tende. Dalla scomposizione e semplificazione dell'oggetto sono state stilizzate dieci diverse forme di nappa.

EN The Nappe collection is an expression of the company's close ties to the local area. It is inspired by the "nappine" (tassels), typically used to close curtains and adorn Venetian salons in the old days. Ten different tassel shapes have been stylised by disassembling and simplifying these decorative objects.

DESIGN BY  
MARCO ZITO

SUSPENSION  
APPLIQUE



NAPPE C3



NAPPE XL2  
NAPPE XL1  
NAPPE XL3



# Olà

IT Un gioiello di design che nasce da una sintesi di esperienza e creatività. Progettata più di dieci anni fa dal laboratorio creativo Masiero, con il contrasto tra la sua semplice struttura in metallo e la lussuosa cascata di pendenti, Olà è un'icona Masiero.

EN A jewel of design born from a synthesis of experience and creativity. Designed more than a decade ago by Masiero's creative atelier, the contrast between its simple metal frame and luxurious cascade of pendants makes Olà a Masiero icon.

DESIGN BY  
MASIERO LAB

SUSPENSION  
CEILING  
APPLIQUE  
TABLE LAMP  
FLOOR LAMP



OLÀ STL2



OLÀ S6 40



OLA S6 OV 160



OLA PL6 90



# Ribbon

IT Ribbon parla di leggerezza contemporanea delle linee, purezza dei materiali e minimalismo dei colori. Questo è Ribbon, dove il metallo cinge il vetro come chiffon bianco avvolto da un nastro nero dalle abili mani di una sarta.

EN Ribbon expresses contemporary lightness in its lines, purity in its materials and minimalism in its colours. This is Ribbon, where metal encircles the glass like white chiffon wrapped in a black ribbon by the skilled hands of a seamstress.

DESIGN BY  
ORIANO FAVARETTO

SUSPENSION  
APPLIQUE  
TABLE LAMP  
FLOOR LAMP



RIBBON S80





RIBBON A37



RIBBON S150



# Crek

IT Crek è espressione di creatività e della capacità veneziana di lavorare il vetro in modo inimitabile al mondo. La forma geometrica ed il vetro effetto cristallo di Rocca donano a Crek le sembianze di una meravigliosa scultura di ghiaccio, che come un Iglù suscita una sensazione di calore e sicurezza.

EN Crek expresses the Venetian ability to work with glass in a way unparalleled anywhere else in the world. With its geometric shape and rock crystal effect glass, Crek resembles a wonderful ice sculpture and evokes the warm, safe sensation of an igloo.

DESIGN BY  
MASIERO LAB

SUSPENSION  
APPLIQUE  
TABLE LAMP  
FLOOR LAMP



CREK S5



CREK TL 1



CREK TL6



CREK STL6



# Sound

IT Che forma avrebbe il suono se fosse un prodotto? Sound ha un design che parla ai nostri sensi, illuminando la nostra mente e l'anima attraverso l'idea di un'armonica melodia progettuale. Il suono è un esperimento semantico formale. È una sinestesia. Sound è una combinazione di elementi circolari che evoca l'espansione delle onde sonore”.

EN What form would sound take if it were a product? The design of Sound speaks to our senses, illuminating our minds and souls through the idea of a harmonious melody of design. Sound is a formal semantic experiment. It is a synaesthesia. Sound is a combination of circular elements evoking the expansion of sound waves.

DESIGN BY  
GIOVANNI BATTISTA  
GIANOLA

SUSPENSION  
CEILING  
APPLIQUE  
TABLE LAMP  
FLOOR LAMP





SOUND TL1



SOUND BIL3



# Palm

IT La applique Palm è un sistema modulare da parete che ricorda il movimento leggiadro delle foglie. Perfette per la decorazione murale grazie alla loro componibilità, Palm trae ispirazione dalla natura. Un progetto pensato per essere composto come un puzzle grazie alle forme che si incastrano.

EN The Palm applique is a modular wall system reminiscent of the graceful movement of leaves. Inspired by nature, Palm's modularity makes it perfect as a wall decoration. Made up of interlocking shapes, the project is conceived to be composed like a jigsaw puzzle.

DESIGN BY  
LETIZIA MAMMINI  
E VALERIA CANDIDO  
APPLIQUE



PALM A21  
COMPOSITION



PALM A40 COMPOSITION



PALM A21 COMPOSITION



# Atelier

IT Nel trascorrere degli anni si sono viste mode susseguirsi tutte prese ad inseguire il tempo che passa, alla ricerca disperata della novità. Con Atelier ci siamo presi il lusso di poterci permettere il tempo, proponendo una gamma di articoli intramontabili.

EN Over the years, fashions have come and gone, chasing time as it passes, desperately seeking novelty. With Atelier, we have allowed ourselves the luxury of taking our time to propose a range of timeless items.

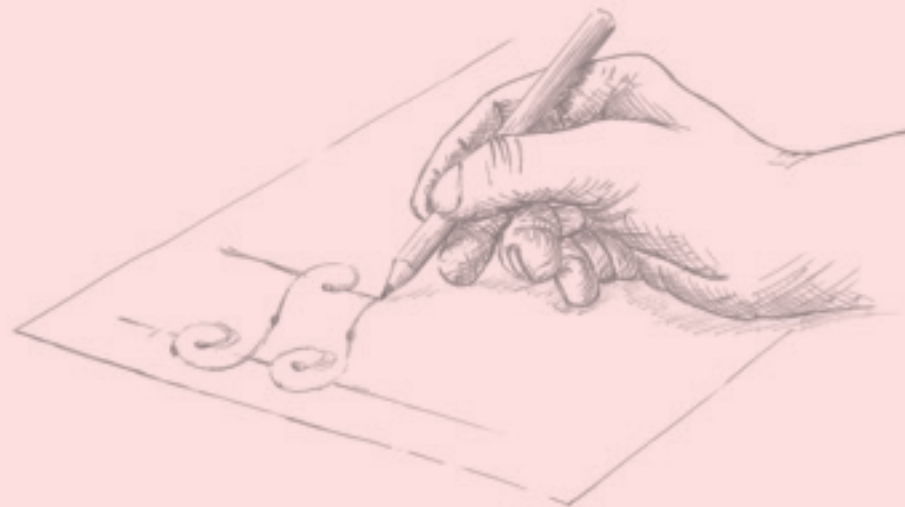

# MT\_ Traditional

IT Il modello Maria Teresa nella versione classica ricrea la stessa atmosfera degli storici palazzi veneziani. Telaio in metallo disponibile in finitura oro lucido e cromo lucido. Braccia ricoperte in vetro trasparente e pendagli disponibili in vetro, Cut Crystal o Premium Crystal.

EN The classic version of the Maria Teresa model recreates the atmosphere of historic Venetian stately homes. The metal frame is available in polished gold or polished chrome. The arms are covered in clear glass and the pendants are available in glass, cut crystal or Premium Crystal.

DESIGN BY  
MASIERO LAB  
CHANDELIER



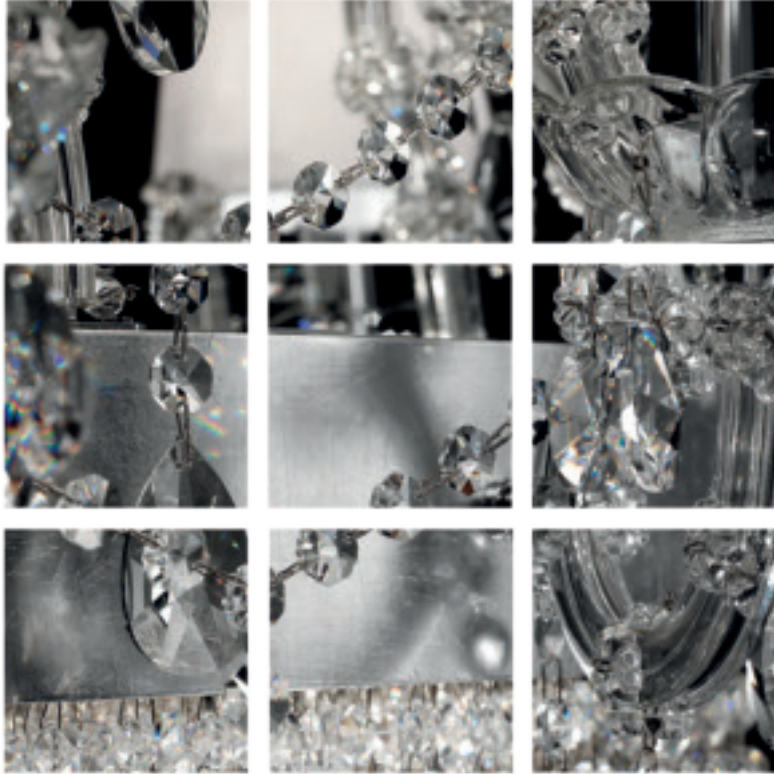

# Maria Teresa DW

IT Il modello Maria Teresa dotato del sistema di illuminazione brevettato LED Bianco Dinamico, permette di personalizzare la temperatura della luce, andando a ricreare il ciclo naturale del sole e scandendo così il ritmo del ciclo circadiano. La luce bianca può essere regolata con una temperatura tra i 2700K e 6500K. Grazie alla tecnologia LED si è pertanto in grado di assecondare l'esigenza di comfort e benessere del corpo umano.

EN With the Maria Teresa model with patented Dynamic White LED lighting system, light temperature can be customised to recreate the natural cycle of the sun, following the rhythm of the circadian cycle. The white light can be adjusted to a temperature between 2700K and 6500K. The LED technology thus makes it possible to provide the comfort and wellness needed by the human body.

DESIGN BY  
MASIERO LAB  
CHANDELIER



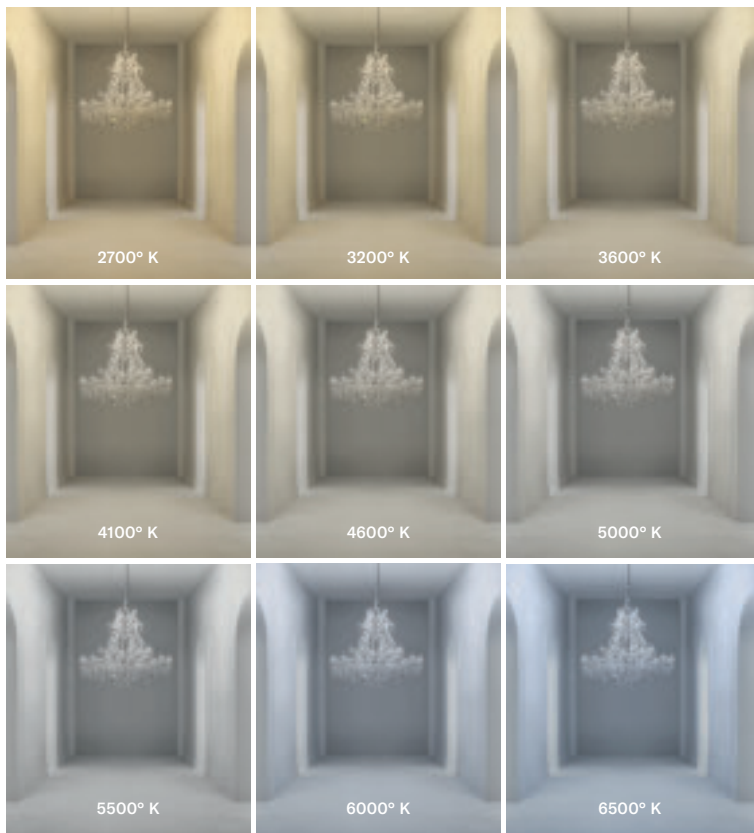

# Maria Teresa RGB-W

IT La tecnologia brevettata Led RGB-W consente di trasformare la luce in puro colore, rinnovando completamente la percezione visiva dello spazio, che si riempie di infinite sfumature. Le superfici cambiano aspetto e l'ambiente muta secondo desiderio ed umore. E' possibile ottenere anche luce bianca a 3000K.

EN The patented RGB-W LED technology transforms light into pure colour, filling the space with infinite nuances for a completely new visual perception. Surfaces alter their appearance and the whole ambience changes according to your wishes and mood. White light at 3000K can also be obtained.

DESIGN BY  
MASIERO LAB  
CHANDELIER



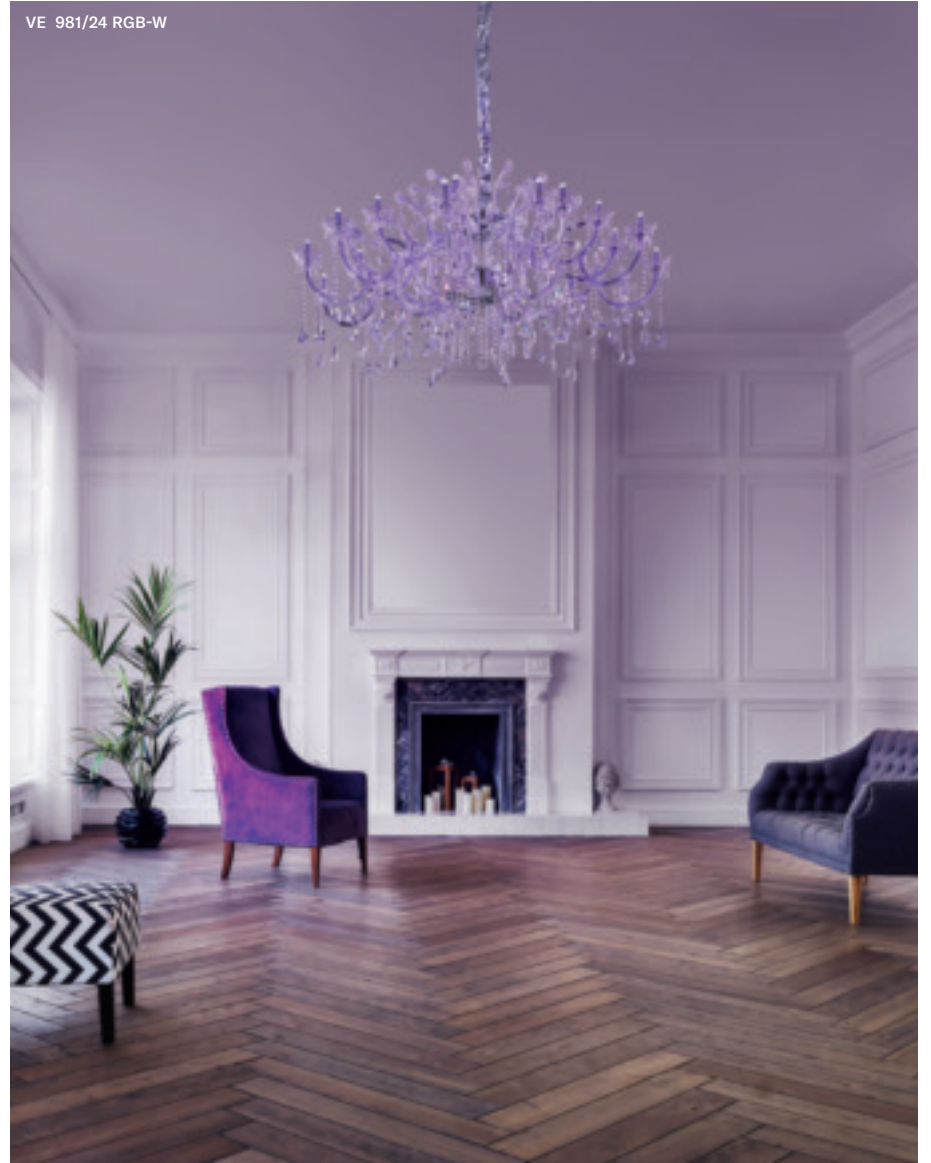



# CG\_Coloured Glass

IT La collezione Maria Teresa in vetro colorato interpreta un classico senza tempo in chiave contemporanea. Il colore è protagonista assoluto e veste il telaio, le braccia, i paralumi ed i pendagli. Telaio in metallo verniciato e pendagli in vetro verniciato disponibili in nove colori. Sistema di illuminazione tradizionale.

EN The Maria Teresa collection in coloured glass interprets a timeless classic with a contemporary twist. Colour is the absolute protagonist, adorning the frame, arms, shades and pendants. The painted metal frame and painted glass pendants are available in a choice of nine colours. Traditional lighting system.

DESIGN BY  
MASIERO LAB  
CHANDELIER





# Impero&Deco

IT L'eleganza inconfondibile di un lusso contemporaneo che prende ispirazione dal gusto rinascimentale, per evolversi in un classico senza tempo. Cadute di cristallo di varie forme e dimensioni riflettono la luce, moltiplicandola all'infinito. Lampadari unici che ricordano una nobile storia, celebrando il bello di un oggetto d'arte.

EN The unmistakable elegance of a contemporary luxury that takes its inspiration from Renaissance taste and evolves it into a timeless classic. Crystal pendants in various shapes and sizes reflect the light and multiply it to infinity. Unique chandeliers revive the noblest history and celebrate the true beauty of a piece of art.

DESIGN BY  
MASIERO LAB  
CHANDELIER



VE 764/S16



VE 811/S12 RD



VE 818/18



VE 843/13

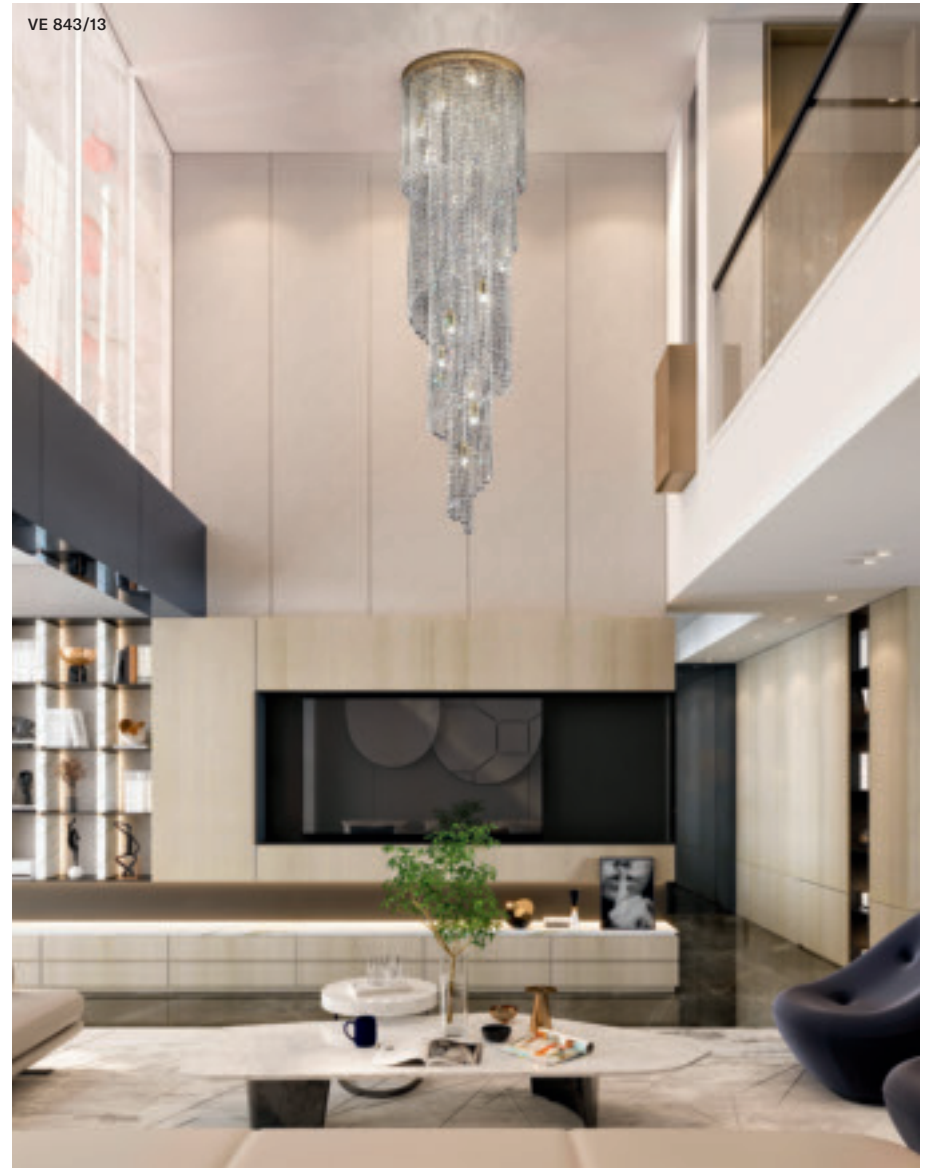

# Raqam

IT Raqam è il lampadario contemporaneo ad illuminazione Led costruito con combinazioni modulari personalizzabili. E' declinabile su tutte le tipologie di superfici, senza limiti di dimensione. Dalla combinazione dei moduli si possono realizzare sospensioni verticali, chandelier, decorazioni a parete e a soffitto, sia per uso residenziale che contract.

EN Raqam is a contemporary chandelier with LED lighting available in customisable modular combinations. It can be used on all types of surface, with no size limits. Combinations of modules can be used to create vertical suspensions, chandeliers and wall and ceiling decorations for both residential and contract use.

DESIGN BY  
MARC SADLER

CEILING  
WALL  
CHANDELIER

RAQAM Q5  
BASIC BATCH E



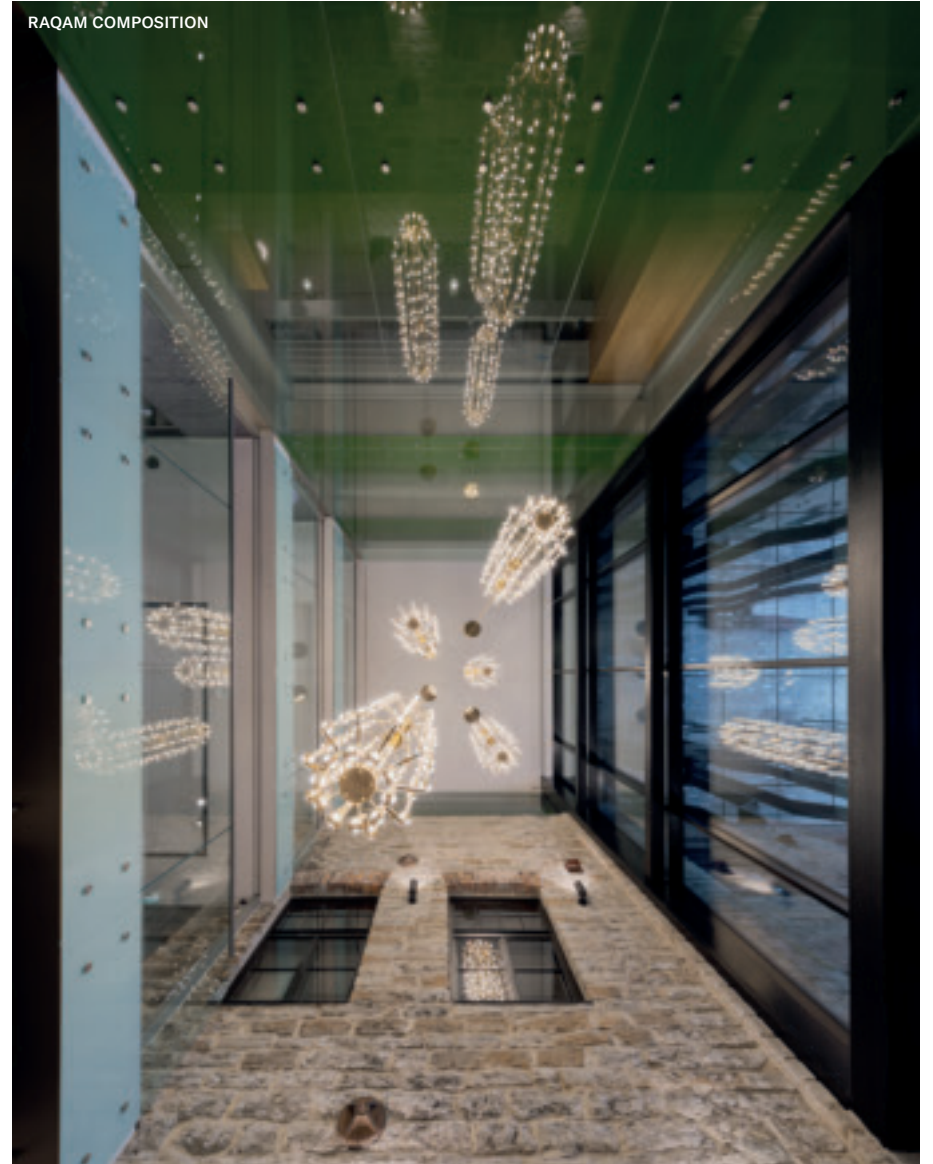

# Cubo

IT Cubo è il sistema illuminante a soffitto o sospensione costruito con moduli su base quadrata o rettangolare, dai quali scendono cadute di pendagli. Dotato di illuminazione tradizionale è adatto a decorare qualsiasi area grazie alla sua modularità.

EN Cubo is a ceiling or suspension lighting system made up of pendants suspended from modules with a square or rectangular base. Fitted with traditional lighting, the availability of modules makes it ideal for decorating any space.

DESIGN BY  
MASIERO LAB

CEILING  
SUSPENSION

CUBO COMBO S 175 SQ





CUBO COMBO PL 175 SQ



CUBO COMBO PL 21 200 SQ



# Galassia

IT Galassia rappresenta una nuova era dei sistemi illuminanti modulari a soffitto. Grazie alla combinazione dei moduli è possibile decorare qualsiasi superficie, creando forme aperte o chiuse dalle quali scenderanno piogge di pendagli.

EN Galassia represents a new era of modular ceiling lighting systems. The modules can be combined to decorate any surface, creating open or closed shapes with showers of hanging pendants.

DESIGN BY  
MASIERO LAB  
CEILING

GALASSIA T2 SNG



GALASSIA O1 SNG



GALASSIA R2 SNG



# Giardini

IT Coniugando design contemporaneo nonché classico con tecnologia di punta, il catalogo Giardini propone soluzioni di illuminazione per l'esterno in grado di soddisfare ogni esigenza e mood d'arredo. Grazie all'utilizzo di materiali di altissima qualità e finiture di pregio, i prodotti da Giardino Masiero sono soluzioni illuminotecniche di eccellenza.

EN Combining both contemporary and classic design with state-of-the-art technology, the Giardini catalogue offers outdoor lighting solutions to meet every need and furnishing mood. The use of top quality materials and fine finishes makes Masiero's Giardini products for the garden lighting solutions of excellence.

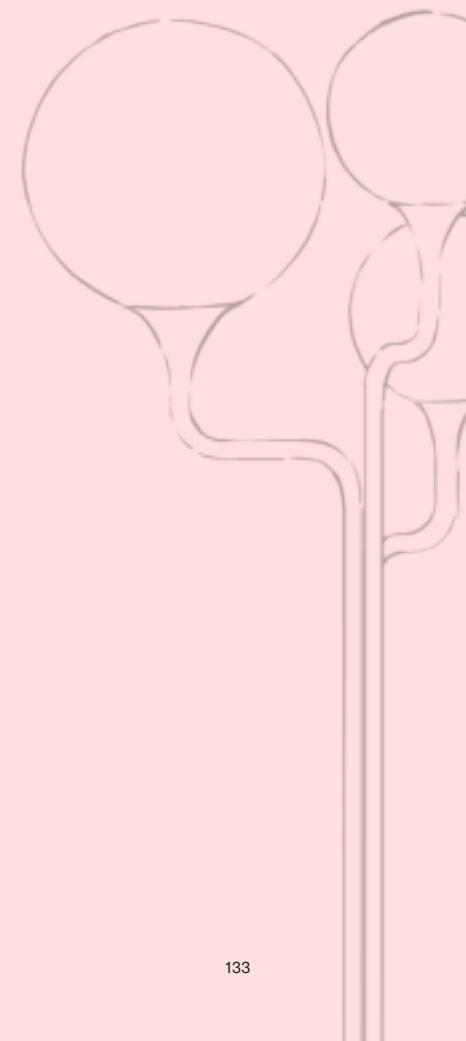

# Cordea

IT Cordea, ispirandosi alle luci degli spazi industriali di un tempo, reinterpreta una forma del passato in una visione sperimentale e contemporanea. Caratterizzata da un'alta fascia a contrasto che ne cinge il diffusore a cappello, è realizzata in forme e materiali studiati in sintonia con cromie volutamente classiche e neutre, capaci di creare atmosfere calde e confortevoli in ogni spazio outdoor.

EN Cordea, inspired by the lights of the industrial spaces of years gone by, reinterprets a shape from the past in an experimental, contemporary vision. Featuring a high-contrast band encircling the cap diffuser, it is made from shapes and materials designed in harmony with deliberately classic, neutral colours, to create a warm and comfortable atmosphere in any outdoor space.

DESIGN BY  
FAVARETTO/PARTNERS

SUSPENSION  
APPLIQUE  
TABLE LAMP



CORDEA OUT A G



CORDEA OUT  
TL PORTABLE





# Tee

IT Tee è un esercizio progettuale di ricerca tra rigore geometrico ed eleganza, contrassegnato esteticamente dalla linea curva. Sfere luminose per gli esterni, animate da linee che richiamano la natura ondulatoria della luce e raccordate su steli curvati a foggia organica, ricordando la delicatezza del fiore di calla.

EN Tee is an exploratory design exercise which balances rigour and elegance, aesthetically distinguished by its curved form. Light spheres for the outdoors are brought to life by contours that reflect the undulating nature of light, connected on organically shaped stems, reminiscent of the gracefulness of the calla lily flower.

DESIGN BY  
VALERIO COMETTI  
+V12DESIGN

SUSPENSION  
CEILING  
APPLIQUE  
TABLE LAMP  
FLOOR LAMP  
BOLLARD  
GROUND

TEE OUT PL5  
TEE OUT GROUND 30





TEE OUT PL1 30



TEE OUT STL3 SELF



TEE OUT STL1 SELF



TEE OUT BOL STAKE 30  
TEE OUT A1 20



# Drylight

IT Drylight è la magia della luce da esterni firmata Masiero. Drylight è l'esclusiva linea brevettata Masiero che riproduce gli iconici lampadari veneziani per uso esterno.

EN Drylight is the magic of outdoor lighting signed by Masiero. Drylight is an exclusive patented Masiero line reproducing the iconic Venetian chandelier for outdoor use.

DESIGN BY  
MASIERO LAB

SUSPENSION  
APPLIQUE  
TABLE LAMP  
FLOOR LAMP

DRYLIGHT S24





DRYLIGHT S6



DRYLIGHT TL6



**LAYOUT**

Masiero

**PHOTO, REPRO**

Loris Casonato

**DIREZIONE ARTISTICA FOTOGRAFICA, STYLING**

NOOII

**PRINT**

Italy, March 2023

by Grafica Antiga

**Masiero srl**

via Peschiere, 53  
31032 Casale sul Sile  
Treviso, Italy  
T +39 0422 7861  
F +39 0422 786250  
info@masierogroup.com  
masierogroup.com

**Masiero USA LTD**

100 Park Avenue  
Suite 1600  
New York, NY 10017  
+1 212 4666754  
sales@masiero-usa.com  
masiero-usa.com

**THANKS TO**

Trabà  
Doimo Salotti  
Miniform  
nb-studio.ru, ph: Mikhail Loskutoff, pag. 122  
Meelis Press Architects, pag.123



[masierogroup.com](http://masierogroup.com)



# GIARDINI

MASIERO





**GIARDINI**

**MASIERO**

# Collections



Cordea  
6

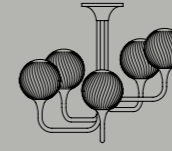

Tee  
30



Drylight  
56

# Collections



# Cordea

IT Cordea, ispirandosi alle luci degli spazi industriali di un tempo, reinterpreta una forma del passato in una visione sperimentale e contemporanea. Caratterizzata da un'alta fascia a contrasto che ne cinge il diffusore a cappello, è realizzata in forme e materiali studiati in sintonia con cromie volutamente classiche e neutre, capaci di creare atmosfere calde e confortevoli in ogni spazio outdoor.

EN Cordea, inspired by the lights of the industrial spaces of years gone by, reinterprets a shape from the past in an experimental, contemporary vision. Featuring a high-contrast band encircling the cap diffuser, it is made from shapes and materials designed in harmony with deliberately classic, neutral colours, to create a warm and comfortable atmosphere in any outdoor space.

DESIGN BY  
FAVARETTO/PARTNERS

SUSPENSION  
APPLIQUE  
TABLE LAMP

CORDEA OUT S  
COMPOSITION





CORDEA OUT  
TL PORTABLE



















# Cordea

Struttura in metallo verniciato decorata con cinturino in gomma. Illuminazione Led. IP54

Painted metal structure decorated with a rubber strap. LED lighting. IP54

Gestell aus lackiertem Metall verziert mit einem Gummiband. LED-Leuchtmittel. IP54

Estructura de metal barnizado decorada con correa de goma. Iluminación LED. IP54

Structure en métal laqué décorée d'un bracelet en caoutchouc. Éclairage LED. IP54

КАРКАС ИЗ ОЦИНКОВАННОГО МЕТАЛЛА, ДЕКОР - КОЛЬЦО ИЗ РЕЗИНЫ. СВЕТОДИОДНОЕ ОСВЕЩЕНИЕ. IP54

饰有橡胶条带的涂色金属灯体结构。Led照明。防护等级IP54

هيكل معدني مطلي مزين بحزام مطاطي صغير. إضاءة ليد IP54

## BAND FINISHING



E50 Windy Blue



E60 Highland



E70 Champagne



E80 Canyon

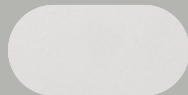

E95 Pure White



E98 Deep Black



BS1 Butter

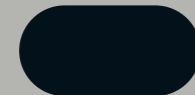

BS2 Black



BS3 Merlot

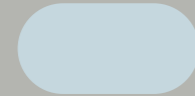

BS4 Baby Blue



BS5 Green Olive

## CORDEA OUT S P

Ø 22 cm / 8.70"  
H 19 cm / 7.50"

### INTEGRATED LED LIGHTING

10 W CRI>90  
3000 K – 1510 NOMINAL LM

DIMM NO

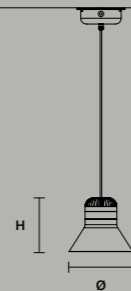

## CORDEA OUT S G

Ø 36 cm / 14.20"  
H 16 cm / 6.30"

### INTEGRATED LED LIGHTING

10 W CRI>90  
3000 K – 1510 NOMINAL LM

DIMM NO

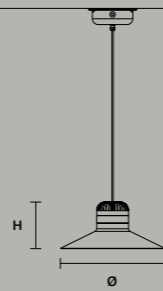

## CORDEA OUT A P

L 22 cm / 8.70"  
H 19 cm / 7.50"  
SP 30 cm / 11.80"

### INTEGRATED LED LIGHTING

10 W CRI>90  
3000 K – 1510 NOMINAL LM

DIMM NO

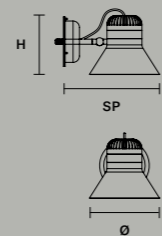

## CORDEA OUT A G

L 36 cm / 14.20"  
H 16 cm / 6.30"  
SP 44 cm / 17.30"

### INTEGRATED LED LIGHTING

10 W CRI>90  
3000 K – 1510 NOMINAL LM

DIMM NO

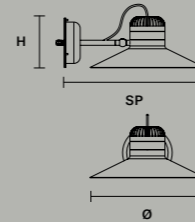

## CORDEA OUT TL PORT

L 22 cm / 8.70"  
H 51 cm / 20.00"  
SP 23.5 cm / 9.30"

### INTEGRATED LED LIGHTING

5 W CRI>90  
3000 K – 600 NOMINAL LM

DIMM OWN BUTTON

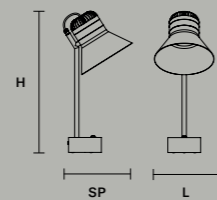

## CORDEA OUT S3 P

### INTEGRATED LED LIGHTING

30 W CRI>90  
3000 K – 4530 NOMINAL LM

DIMM TRIAC

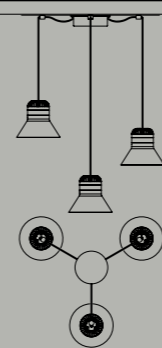

## CORDEA OUT S5 P

### INTEGRATED LED LIGHTING

50 W CRI>90  
3000 K – 7550 NOMINAL LM

DIMM TRIAC

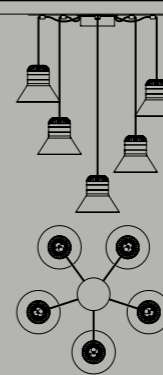

## CORDEA OUT S3 G

### INTEGRATED LED LIGHTING

30 W CRI>90  
3000 K – 4530 NOMINAL LM

DIMM TRIAC

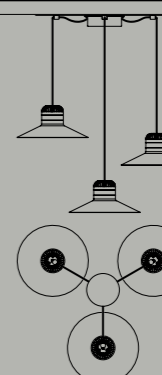



## CORDEA OUT S5 G

### INTEGRATED LED LIGHTING

50 W CRI>90  
3000 K – 7550 NOMINAL LM

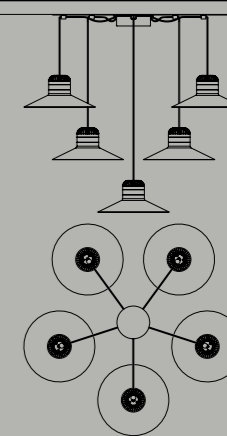
DIMM TRIAC



 For the US market, refer to the relevant price list.

Finishings

BAND	FRAME					
BS1 Butter	E50 Windy Blue	E60 Highland	E70 Champagne	E80 Canyon	E95 Pure White	E98 Deep Black
						
BS2 Black	E50 Windy Blue	E60 Highland	E70 Champagne	E80 Canyon	E95 Pure White	E98 Deep Black
						
BS3 Merlot	E50 Windy Blue	E60 Highland	E70 Champagne	E80 Canyon	E95 Pure White	E98 Deep Black
						
BS4 Baby Blue	E50 Windy Blue	E60 Highland	E70 Champagne	E80 Canyon	E95 Pure White	E98 Deep Black
						
BS5 Green Olive	E50 Windy Blue	E60 Highland	E70 Champagne	E80 Canyon	E95 Pure White	E98 Deep Black
						

# Tee

IT Tee è un esercizio progettuale di ricerca tra rigore geometrico ed eleganza, contrassegnato esteticamente dalla linea curva. Sfere luminose per gli esterni, animate da linee che richiamano la natura ondulatoria della luce e raccordate su steli curvati a foggia organica, ricordando la delicatezza del fiore di calla.

EN Tee is an exploratory design exercise which balances rigour and elegance, aesthetically distinguished by its curved form. Light spheres for the outdoors are brought to life by contours that reflect the undulating nature of light, connected on organically shaped stems, reminiscent of the gracefulness of the calla lily flower.

DESIGN BY  
VALERIO COMETTI  
+V12DESIGN

SUSPENSION  
CEILING  
APPLIQUE  
TABLE LAMP  
FLOOR LAMP  
BOLLARD  
GROUND

TEE OUT PL5  
TEE OUT GROUND 30







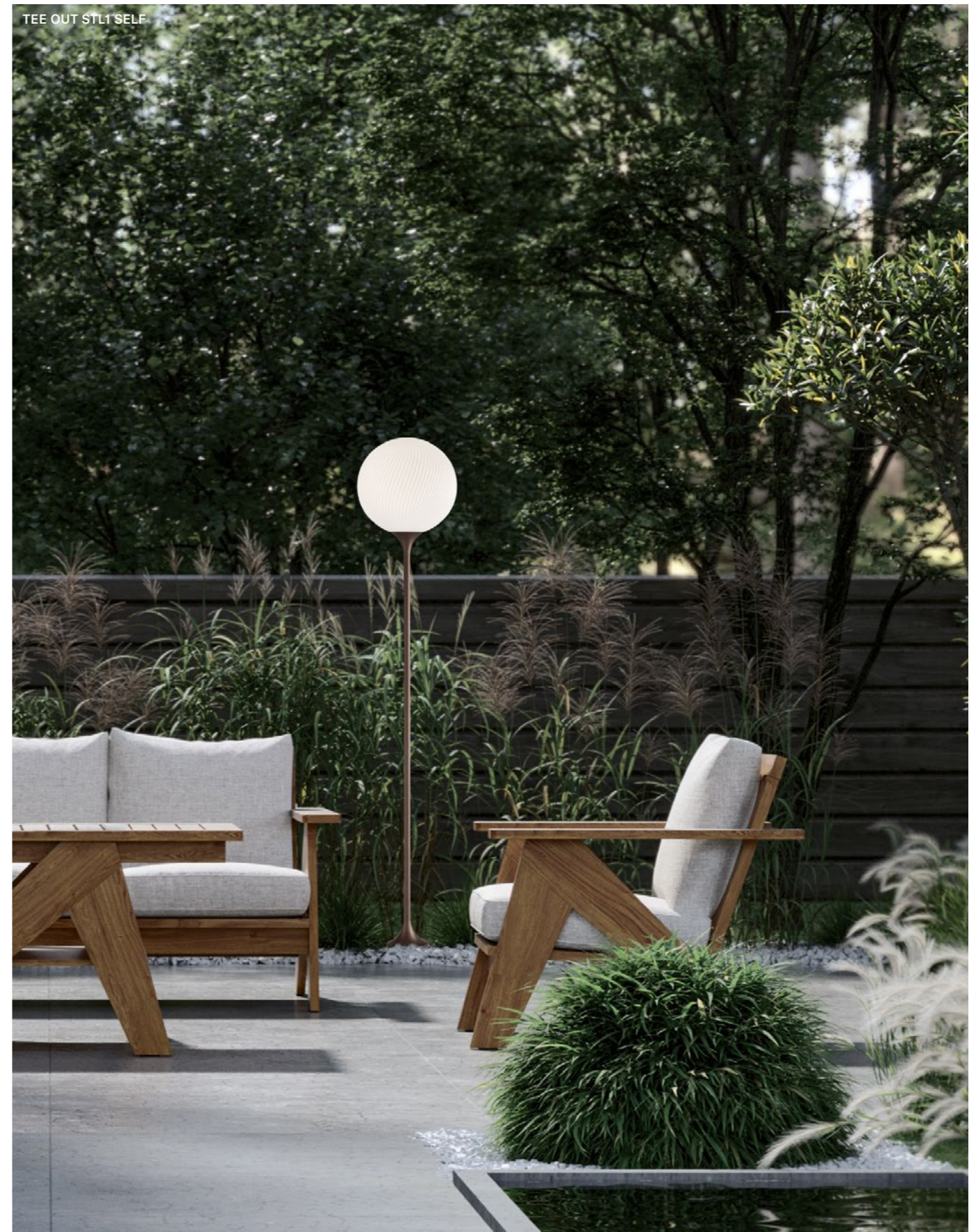





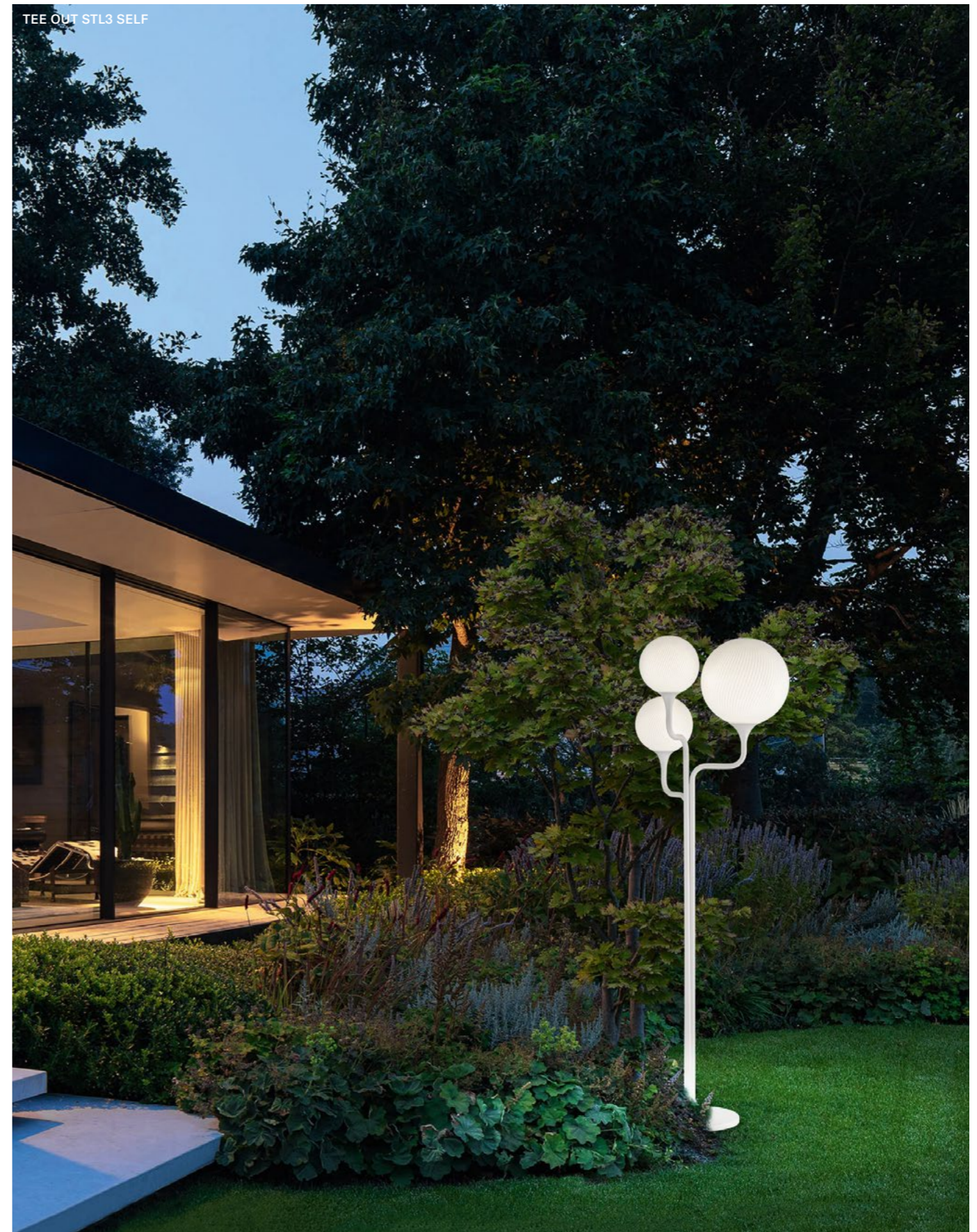





TEE OUT BOL FIX 20

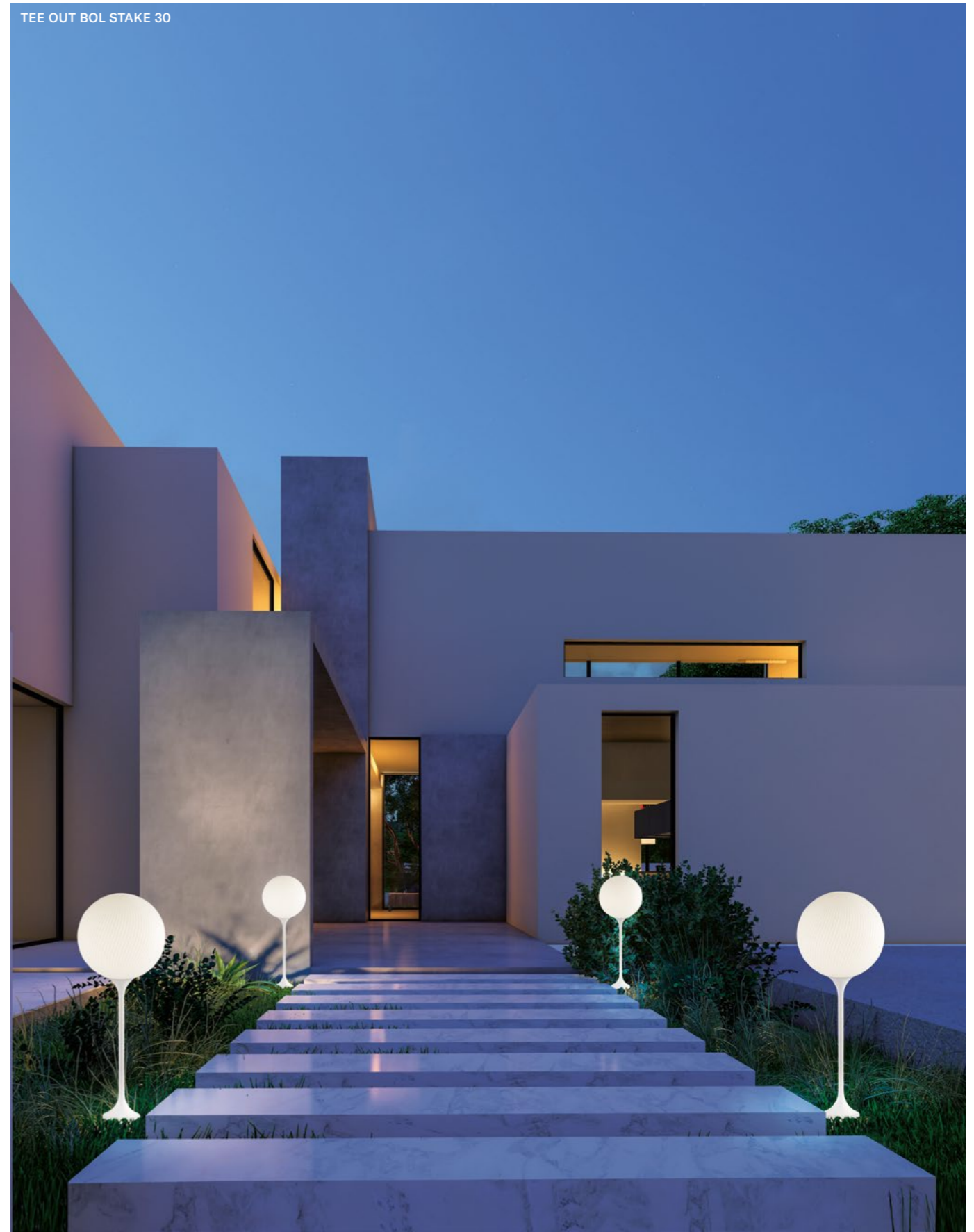

TEE OUT TL1 20  
TEE OUT STL1 SELF









# Tee

Struttura in metallo verniciato.  
Diffusori in polietilene.  
Illuminazione tradizionale. IP54

Painted metal structure.  
Polyethylene diffusers.  
Traditional lighting. IP54

Gestell aus lackiertem Metall.  
Schirme aus Polyethylen.  
Herkömmliche Leuchtmittel. IP54

Estructura en metal barnizado.  
Difusores en polietileno.  
Iluminación tradicional. IP54

Structure en métal laqué.  
Diffuseurs en polyéthylène.  
Éclairage traditionnel. IP54

КАРКАС ИЗ ОКРАШЕННОГО МЕТАЛЛА.  
ПЛАФОНЫ ИЗ ПОЛИЭТИЛЕНА.  
ТРАДИЦИОННОЕ ОСВЕЩЕНИЕ. IP54

涂色金属灯体结构。聚乙烯灯罩。  
传统照明。防护等级IP54

هيكل معدني مطلي. ناشرات ضوء من البولي إيثيلين  
IP54. إضاءة تقليدية.



E81 Hazelnut

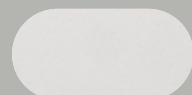

E95 Pure White



Polyethylene diffusers

For the US market, refer to the relevant price list.

## TEE OUT S1 20

Ø 20 cm / 7.90"  
H 30 cm / 11.80"

### STANDARD LIGHTING

1 x E14x10 W MAX (NOT INCL.)\*  
USA 1 x E12x40 W MAX (NOT INCL.)\*

\* BULB MAX Ø 37 mm L 110 mm

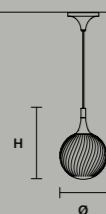

## TEE OUT S1 30

Ø 30 cm / 11.80"  
H 40 cm / 15.70"

### STANDARD LIGHTING

1 x E27x20 W MAX (NOT INCL.)\*  
USA 1 x E26x60 W MAX (NOT INCL.)\*

\* BULB MAX Ø 62 mm L 185 mm



## TEE OUT PL1 20

Ø 20 cm / 7.90"  
H 49 cm / 19.30"

### STANDARD LIGHTING

1 x E14x10 W MAX (NOT INCL.)\*  
USA 1 x E12x40 W MAX (NOT INCL.)\*

\* BULB MAX Ø 37 mm L 110 mm

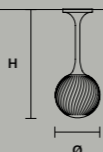

## TEE OUT PL1 30

Ø 30 cm / 11.80"  
H 64 cm / 25.20"

### STANDARD LIGHTING

1 x E27x20 W MAX (NOT INCL.)\*  
USA 1 x E26x60 W MAX (NOT INCL.)\*

\* BULB MAX Ø 62 mm L 185 mm



## TEE OUT PL5

Ø 85 cm / 33.50"  
H 68 cm / 26.80"

### STANDARD LIGHTING

5 x E14x10 W MAX (NOT INCL.)\*  
USA 5 x E12x40 W MAX (NOT INCL.)\*

\* BULB MAX Ø 37 mm L 110 mm

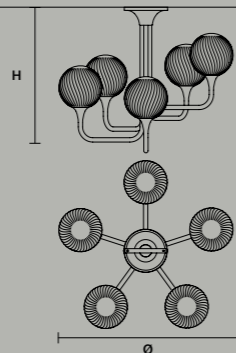

## TEE OUT PL6 95

Ø 94 cm / 37.00"  
H 66.5 cm / 26.20"

### STANDARD LIGHTING

6 x E14x10 W MAX (NOT INCL.)\*  
USA 6 x E12x40 W MAX (NOT INCL.)\*

\* BULB MAX Ø 37 mm L 110 mm

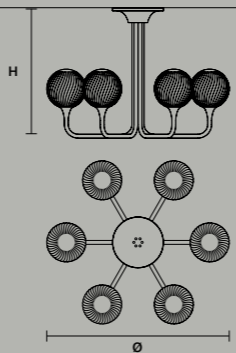

## TEE OUT PL8 RD 120

Ø 120 cm / 47.20"  
H 76.5 cm / 30.10"

### STANDARD LIGHTING

8 x E14x10 W MAX (NOT INCL.)\*  
USA 8 x E12x40 W MAX (NOT INCL.)\*

\* BULB MAX Ø 37 mm L 110 mm

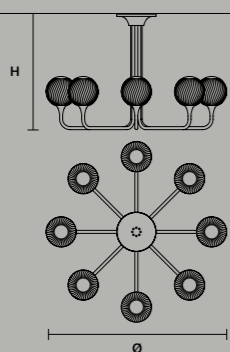

## TEE OUT PL8 RD 160

Ø 167 cm / 65.70"  
H 83.5 cm / 32.90"

### STANDARD LIGHTING

8 x E27x20 W MAX (NOT INCL.)\*  
USA 8 x E26x60 W MAX (NOT INCL.)\*

\* BULB MAX Ø 62 mm L 185 mm

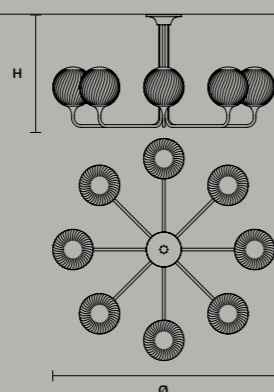

## TEE OUT PL4+4 RD 100

Ø 100 cm / 39.40"  
H 100 cm / 39.40"

### STANDARD LIGHTING

8 x E14x10 W MAX (NOT INCL.)\*  
USA 8 x E12x40 W MAX (NOT INCL.)\*

\* BULB MAX Ø 37 mm L 110 mm

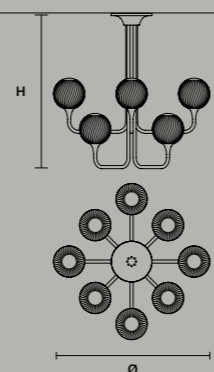

## TEE OUT PL5+5 RD 120

Ø 120 cm / 47.20"  
H 83.5 cm / 32.90"

### STANDARD LIGHTING

10 x E14x10 W MAX (NOT INCL.)\*  
USA 10 x E12x40 W MAX (NOT INCL.)\*

\* BULB MAX Ø 37 mm L 110 mm

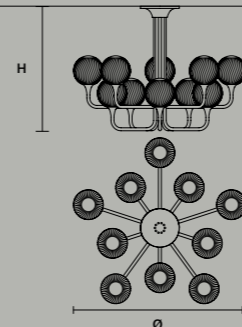

## TEE OUT A1 20

L 20 cm / 7.90"  
H 41 cm / 16.10"  
SP 26 cm / 10.20"

### STANDARD LIGHTING

1 x E14x10 W MAX (NOT INCL.)\*  
USA 1 x E12x40 W MAX (NOT INCL.)\*

\* BULB MAX Ø 37 mm L 110 mm

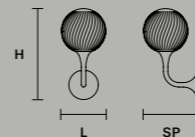

## TEE OUT PL8 OV 120

L 120 cm / 47.20"  
H 63.5 cm / 25.00"  
SP 80 cm / 31.50"

### STANDARD LIGHTING

8 x E14x10 W MAX (NOT INCL.)\*  
USA 8 x E12x40 W MAX (NOT INCL.)\*

\* BULB MAX Ø 37 mm L 110 mm

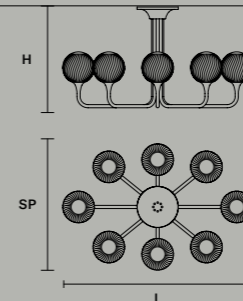

## TEE OUT TL1 20

Ø 20 cm / 7.90"  
H 48 cm / 18.90"

### STANDARD LIGHTING

1 x E14x10 W MAX (NOT INCL.)\*  
USA 1 x E12x40 W MAX (NOT INCL.)\*

\* BULB MAX Ø 37 mm L 110 mm



## TEE OUT GROUND 30

Ø 30 cm / 11.80"  
H 33 cm / 13.00"

### STANDARD LIGHTING

1 x E27x20 W MAX (NOT INCL.)\*  
USA 1 x E26x60 W MAX (NOT INCL.)\*

\* BULB MAX Ø 62 mm L 185 mm





**TEE OUT BOL FIX 20**  IP54

∅ 20 cm / 7.90"  
H 55 cm / 21.70"

**STANDARD LIGHTING**  
1xE14x10 W MAX (NOT INCL.)\*  
USA 1xE12x40 W MAX (NOT INCL.)\*

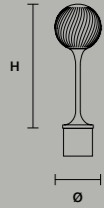
\* BULB MAX Ø 37 MM L 110 MM





**TEE OUT BOL STAKE 20**  IP44

∅ 20 cm / 7.90"  
H 55 cm / 21.70"

**STANDARD LIGHTING**  
1xE14x10 W MAX (NOT INCL.)\*  
USA 1xE12x40 W MAX (NOT INCL.)\*

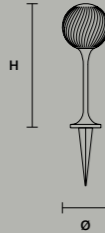
\* BULB MAX Ø 37 MM L 110 MM





**TEE OUT BOL FIX 30**  IP54

∅ 30 cm / 11.80"  
H 80 cm / 31.50"

**STANDARD LIGHTING**  
1xE27x20 W MAX (NOT INCL.)\*  
USA 1xE26x60 W MAX (NOT INCL.)\*

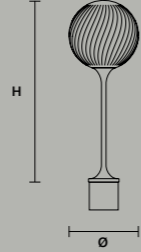
\* BULB MAX Ø 62 mm L 185 mm



**TEE OUT BOL STAKE 30**  IP44

∅ 30 cm / 11.80"  
H 80 cm / 31.50"

**STANDARD LIGHTING**  
1xE27x20 W MAX (NOT INCL.)\*  
USA 1xE26x60 W MAX (NOT INCL.)\*

\* BULB MAX Ø 62 mm L 185 mm

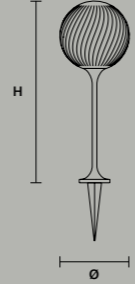

**TEE OUT STL1 SELF**  IP44

∅ 30 cm / 11.80"  
H 160 cm / 63.00"

**STANDARD LIGHTING**  
1xE27x20 W MAX (NOT INCL.)\*  
USA 1xE26x60 W MAX (NOT INCL.)\*

\* BULB MAX Ø 62 mm L 185 mm

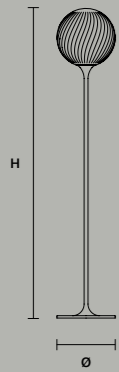

**TEE OUT STL1 FIX**  IP54

∅ 30 cm / 11.80"  
H 160 cm / 63.00"

**STANDARD LIGHTING**  
1xE27x20 W MAX (NOT INCL.)\*  
USA 1xE26x60 W MAX (NOT INCL.)\*

\* BULB MAX Ø 62 mm L 185 mm

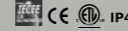

**TEE OUT STL1 STAKE**  IP44

∅ 30 cm / 11.80"  
H 160 cm / 63.00"

**STANDARD LIGHTING**  
1xE27x20 W MAX (NOT INCL.)\*  
USA 1xE26x60 W MAX (NOT INCL.)\*

\* BULB MAX Ø 62 mm L 185 mm



**TEE OUT STL3 SELF**  IP44

L 52 cm / 20.50"  
H 170 cm / 66.90"  
SP 45 cm / 17.70"

**STANDARD LIGHTING**  
2xE14x10 W MAX (NOT INCL.)\*  
1xE27x20 W MAX (NOT INCL.)\*\*  
USA 2xE12x40 W MAX (NOT INCL.)\*  
1xE26x60 W MAX (NOT INCL.)\*\*

\* BULB MAX Ø 37 MM L 110 MM  
\*\* BULB MAX Ø 62 mm L 185 mm

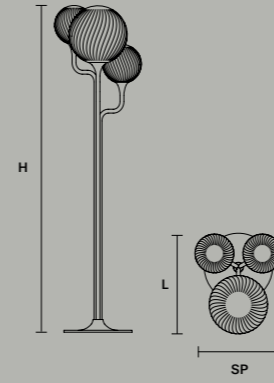



**TEE OUT STL3 FIX**  IP54

L 52 cm / 20.50"  
H 170 cm / 66.90"  
SP 45 cm / 17.70"

**STANDARD LIGHTING**  
2xE14x10 W MAX (NOT INCL.)\*  
1xE27x20 W MAX (NOT INCL.)\*\*  
USA 2xE12x40 W MAX (NOT INCL.)\*  
1xE26x60 W MAX (NOT INCL.)\*\*

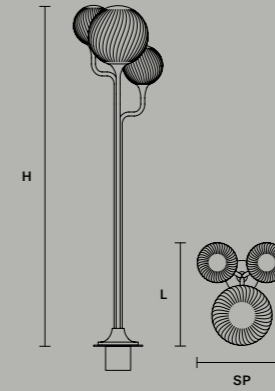
\* BULB MAX Ø 37 MM L 110 MM  
\*\* BULB MAX Ø 62 mm L 185 mm



**TEE OUT STL3 STAKE**  IP44

L 52 cm / 20.50"  
H 170 cm / 66.90"  
SP 45 cm / 17.70"

**STANDARD LIGHTING**  
2xE14x10 W MAX (NOT INCL.)\*  
1xE27x20 W MAX (NOT INCL.)\*\*  
USA 2xE12x40 W MAX (NOT INCL.)\*  
1xE26x60 W MAX (NOT INCL.)\*\*

\* BULB MAX Ø 37 MM L 110 MM  
\*\* BULB MAX Ø 62 mm L 185 mm

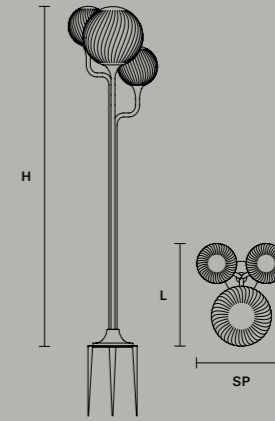

**TEE OUT S3**  IP54

**STANDARD LIGHTING**  
3xE27x20 W MAX (NOT INCL.)\*  
USA 3xE26x60 W MAX (NOT INCL.)\*

\* BULB MAX Ø 62 mm L 185 mm



**TEE OUT S5**  IP54

**STANDARD LIGHTING**  
5xE14x10 W MAX (NOT INCL.)\*  
USA 5xE12x40 W MAX (NOT INCL.)\*

\* BULB MAX Ø 37 MM L 110 MM



# Drylight

IT Drylight è la collezione di lampadari veneziani per esterni che porta la magica atmosfera di Venezia nei terrazzi, dehors e giardini. Cristalli e pendenti dalle fogge settecentesche creano scenari luminosi ovattati, affascinanti e misteriosi, ottenuti con i più avanzati sistemi di domotica.

EN Drylight is the Venetian outdoor chandelier collection that brings the magical atmosphere of Venice to terraces, patios and gardens. The 18th-century style crystals and pendants create hushed, captivating, mysterious lighting environment, achieved through the most advanced home automation systems.

DESIGN BY  
MASIERO LAB

SUSPENSION  
APPLIQUE  
TABLE LAMP  
FLOOR LAMP

DRYLIGHT S24





## Tecnologia Drylight con protezione IP66: sicurezza totale in ogni condizione climatica

Drylight technology with IP66 protection level: complete safety in any weather conditions



**CERTIFICAZIONE IP66**  
Totale protezione contro l'acqua.  
**IP66 CERTIFICATION**  
Total protection against water.



**ILLUMINAZIONE A LUCE LED BIANCA OPPURE A LED RGB-W**  
Possibilità di ricreare infiniti scenari grazie alla tecnologia RGB-W.  
**WHITE LED LIGHTING OR RGB-W LED LIGHTING**  
Possibility to recreate countless scenario thanks to RGB-W technology.



**RESISTENTE AI RAGGI UV**  
Sviluppato con struttura in Policarbonato che non cristallizza o ingiallisce, testato per gli ambienti estremi.  
**UV RESISTANT**  
The structure is made of Polycarbonate, a material not subject to crystallization or yellowing, tested for extreme environments.



**RESISTENTE ALLE ALTE E BASSE TEMPERATURE**  
Testato in camera climatica con escursioni termiche ripetute da -30 °C a +50°C.  
**RESISTANT TO HIGH AND LOW TEMPERATURES**  
Tested in climate chamber, with a temperature range from -30 °C to +50 °C.



**VERSIONE RGB-W COMPATIBILE CON PROTOCOLLO DMX**  
Gestibile attraverso i più avanzati sistemi domotici.  
**RGB-W VERSION COMPATIBLE WITH DMX PROTOCOLS**  
Suitable for the most advanced home automation systems.



**SEMPLICITÀ DI INSTALLAZIONE E MANUTENZIONE**  
**EASY INSTALLATION AND LOW MAINTENANCE**



**RESISTENTE A UMIDITÀ, POLVERE E CORROSIONE**  
Ideale per utilizzi in bagni, SPA e piscine. Testato in nebbia salina, ideale per aree costiere e utilizzi marittimi.  
**HUMIDITY, DUST AND CORROSION RESISTANT**  
Suitable for installation in baths, spas and swimming pools. Tested in saline fog, ideal for coastal areas and marine use.



**RESISTENTE ALLE SOLLECITAZIONI E AL VENTO**  
Testato in galleria del vento fino ad oltre 80 Km/h. (Solo Versione Extreme)  
**RESISTANT TO STRESS AND WIND**  
Tested in wind tunnel, with wind speeds higher than 80 Km/h. (Extreme version only)



Drylight è disponibile in versione Extreme, con pendagli e prismi in policarbonato, consigliata per uso esterno e in versione Premium, con pendagli ed ottagoni in cristallo molato raccomandata per uso interno.

Drylight is available in the Extreme version, with polycarbonate pendants and prisms, recommended for outdoor use, and in the Premium version, with cut crystal pendants and octagons, recommended for indoor use.



**EXTREME**

Pendagli e prismi in policarbonato.  
Polycarbonate pendants and prisms.



**PREMIUM**

Pendagli e ottagoni in cristallo molato.  
(Consigliato per uso interno).  
Cut crystal pendants and octagons.  
(Recommended for internal use only).







Disponibile in versione RGB-W con la possibilità di generare un'infinita gamma di colori, oppure in versione WHITE, che consente di intervenire solo sull'intensità della luce bianca.

Available in the RGB-W version, with the possibility of generating an infinite range of colours, and WHITE, with the possibility of modifying only the intensity of the white light.



**DRYLIGHT LED WHITE**



**DRYLIGHT LED RGB-W**

Drylight incorpora un sistema LED RGB-W ingegnerizzato per rispondere in modo efficiente alle esigenze di affidabilità e robustezza. Utilizza una soluzione brevettata che consente di realizzare infiniti scenari di intensità e colore della luce.

Drylight incorporates a LED RGB-W system engineered to efficiently meet the needs for reliability and strength. It is equipped with a patented system that allows to create endless combinations of light intensity and colour.

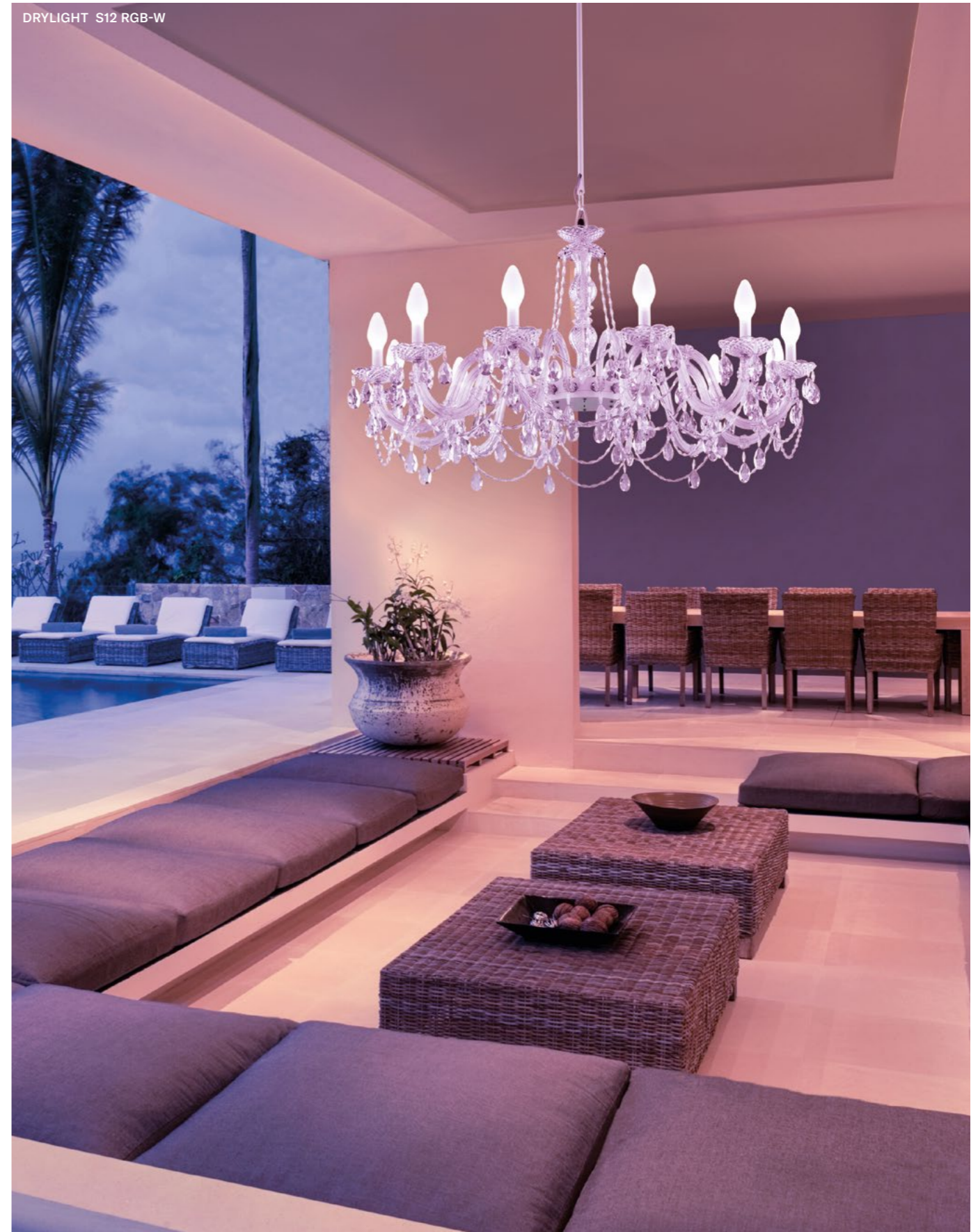



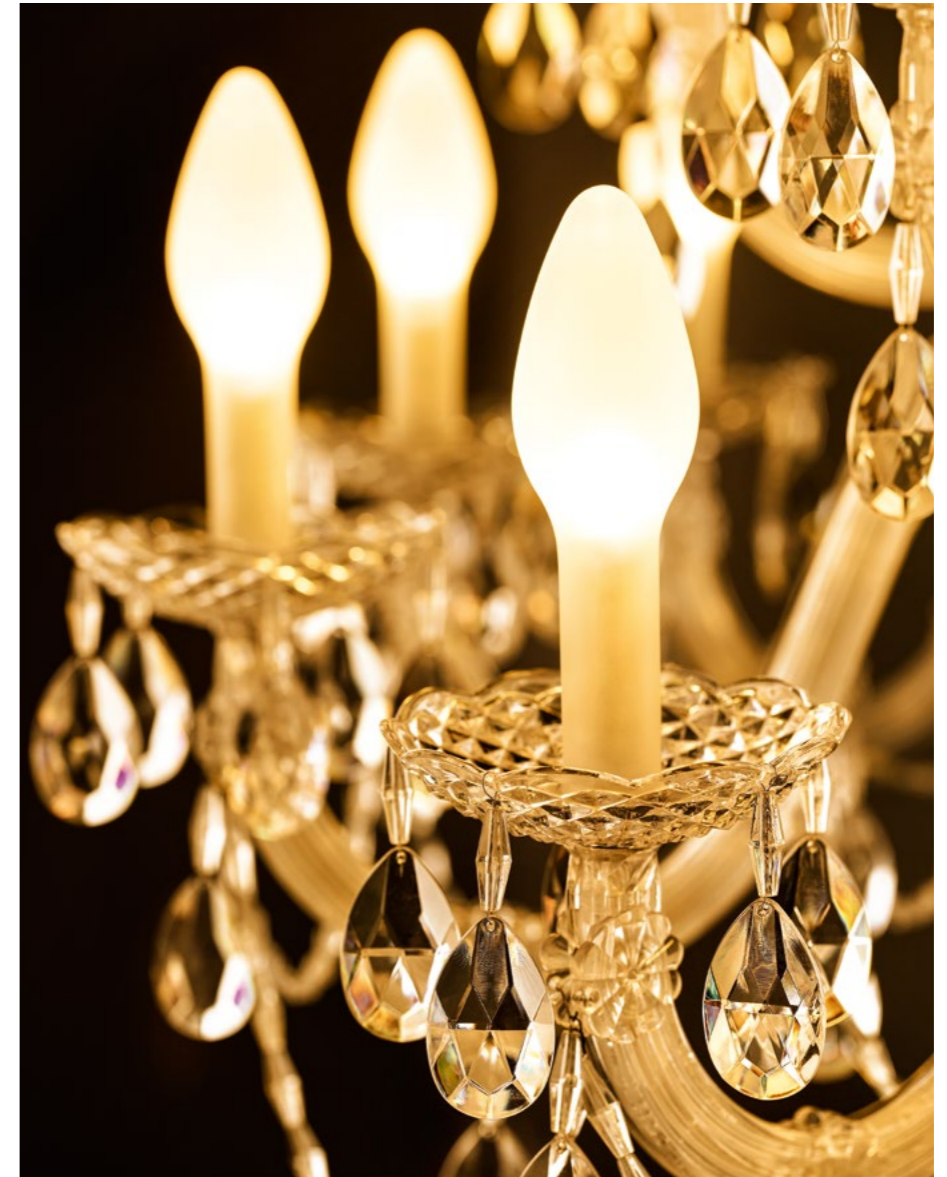







DRYLIGHT A2 RGB-W

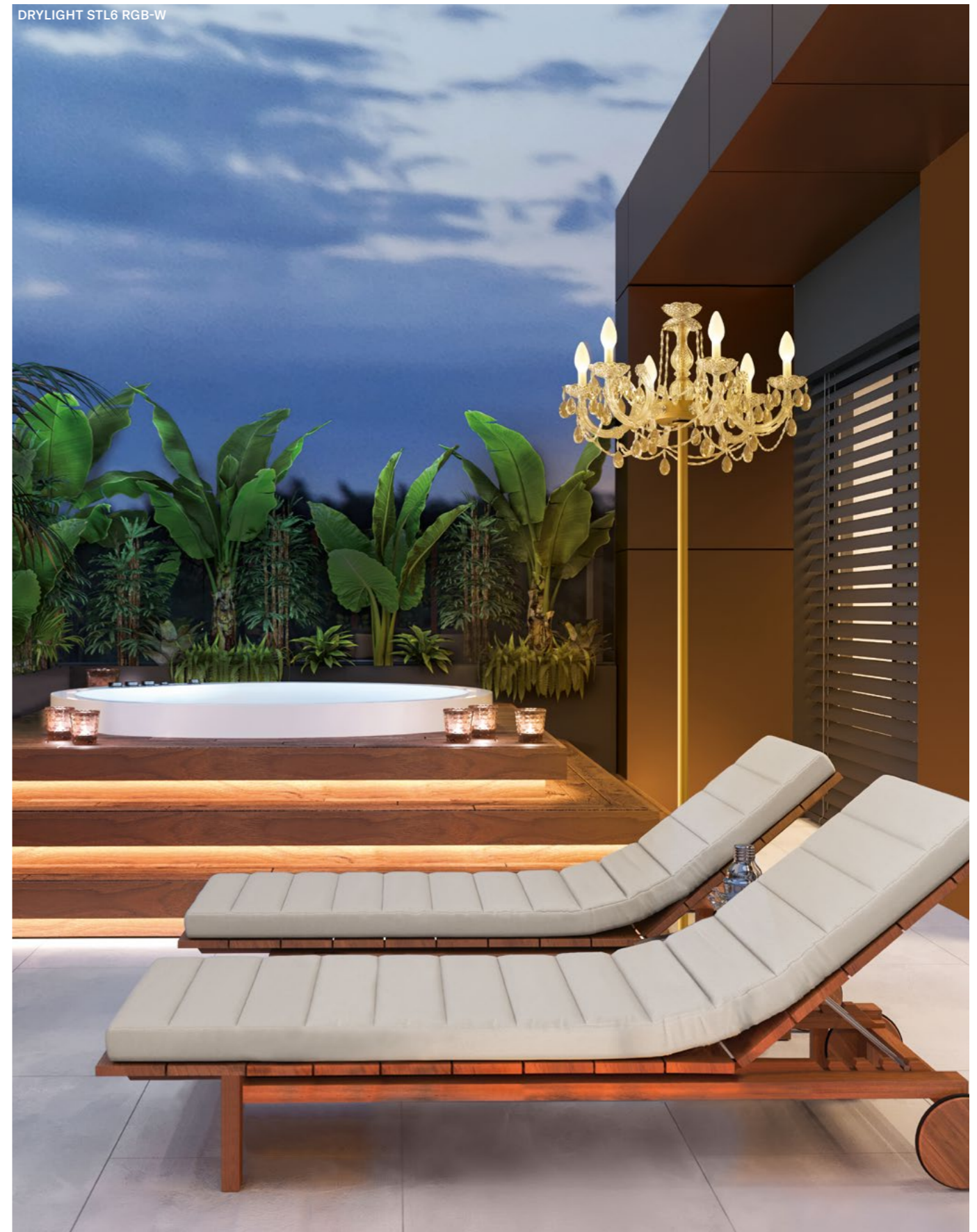

DRYLIGHT STL6 RGB-W





DRYLIGHT A2  
DRYLIGHT S12





# Drylight

Struttura in policarbonato con pendagli in policarbonato o cristallo molato (raccomandato per uso interno). Illuminazione Led. IP66

Polycarbonate structure with polycarbonate pendants or cut crystal (recommended for indoor use). LED lighting. IP66

Gestell aus Polycarbonat mit Behang aus Polycarbonat oder geschliffenem Kristall (für den Innenbereich empfohlen). LED-Leuchtmittel. IP66

Estructura en policarbonato con colgantes en policarbonato o cristal tallado (recomendado para uso interno). Iluminación LED. IP66

Structure en polycarbonate avec pampilles en polycarbonate ou cristal taillé (recommandé pour une utilisation à l'intérieur). Éclairage LED. IP66

КАРКАС ИЗ ПОЛИКАРБОНАТА С ПОДВЕСКАМИ ИЗ ПОЛИКАРБОНАТА ИЛИ ШЛИФОВАННОГО СТЕКЛА (РЕКОМЕНДУЕТСЯ ДЛЯ ВНУТРЕННЕГО ИСПОЛЬЗОВАНИЯ). СВЕТОДИОДНОЕ ОСВЕЩЕНИЕ. IP66

帶有聚碳酸酯或切割水晶吊墜的聚碳酸酯燈體結構(建議室內使用)。Led照明。防護等級IP66

هيكل من البولي كربونات مع دلائل من البولي كربونات أو الكريستال المصقول (موصى به للاستخدام الداخلي). إضاءة ليد . IP66



E71 Silver Chrome

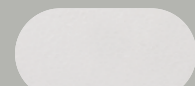

E95 Pure White



E99 Desert Gold

For the US market, refer to the relevant price list.

## LIGHTING

### 1. Drylight Led White

**2. Drylight Led RGB-W:** Drylight incorpora un sistema LED RGB-W ingegnerizzato per rispondere alle esigenze di affidabilità e robustezza. Utilizza una soluzione brevettata che consente di realizzare infiniti scenari di intensità e colore della luce.

### 1. Drylight Led White

**2. Drylight Led RGB-W:** Drylight incorporates a LED RGB-W system engineered to meet the needs for reliability and strength. It is equipped with a patented system that allows to create endless combinations of light intensity and colour.



## MATERIALS



**EXTREME PENDANTS**  
Pendagli e prismi in policarbonato. Polycarbonate pendants and prisms.



**PREMIUM PENDANTS**  
Pendagli e ottagoni in cristallo molato. (Consigliato per uso interno). Cut crystal pendants and octagons. (Recommended for internal use only).

## RGB-W CONTROL

Il sistema RGB-W Control è dotato di una centralina\* di controllo che consente di gestire tutte le funzioni in base alle esigenze dell'utilizzatore. Ogni dispositivo Drylight RGB-W può essere integrato nei sistemi domotici di qualsiasi abitazione gestiti con protocollo DMX.

Su richiesta è possibile fornire il dispositivo di uno di questi sistemi di gestione:

**1. Radiocomando:** ogni singolo dispositivo può essere controllato con un radiocomando. Su richiesta, un unico radiocomando può gestire più dispositivi diversi.

**2. App su smartphone o tablet:** Masiero ha sviluppato una App disponibile per sistemi IOS e Android che, con un'interfaccia semplice ed intuitiva, permette di gestire un numero infinito di dispositivi, contemporaneamente oppure singolarmente.

\* Centralina non inclusa

The control unit\* in the RGB-W Control system allows all functions to be managed according to the user's needs. Each Drylight RGB-W device can be integrated into any home automation system managed with the DMX protocol.

On request, the device can be provided with one of the following control systems:

**1. Radio control:** each individual device can be controlled via a radio remote control. On request, a single remote control can manage several different devices.

**2. App on your smartphone or tablet:** Masiero has developed an app for IOS and Android systems with a simple, intuitive interface to allow an infinite number of devices to be controlled together or individually.

\* Control unit not included

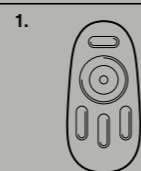

## MASIERO SMART LIGHT APP

Con la App Masiero Smart Light si possono gestire un numero infinito di dispositivi, tramite il sistema Host-slave.

With the Masiero Smart Light App, an infinite number of appliances can be controlled through the host-slave system.

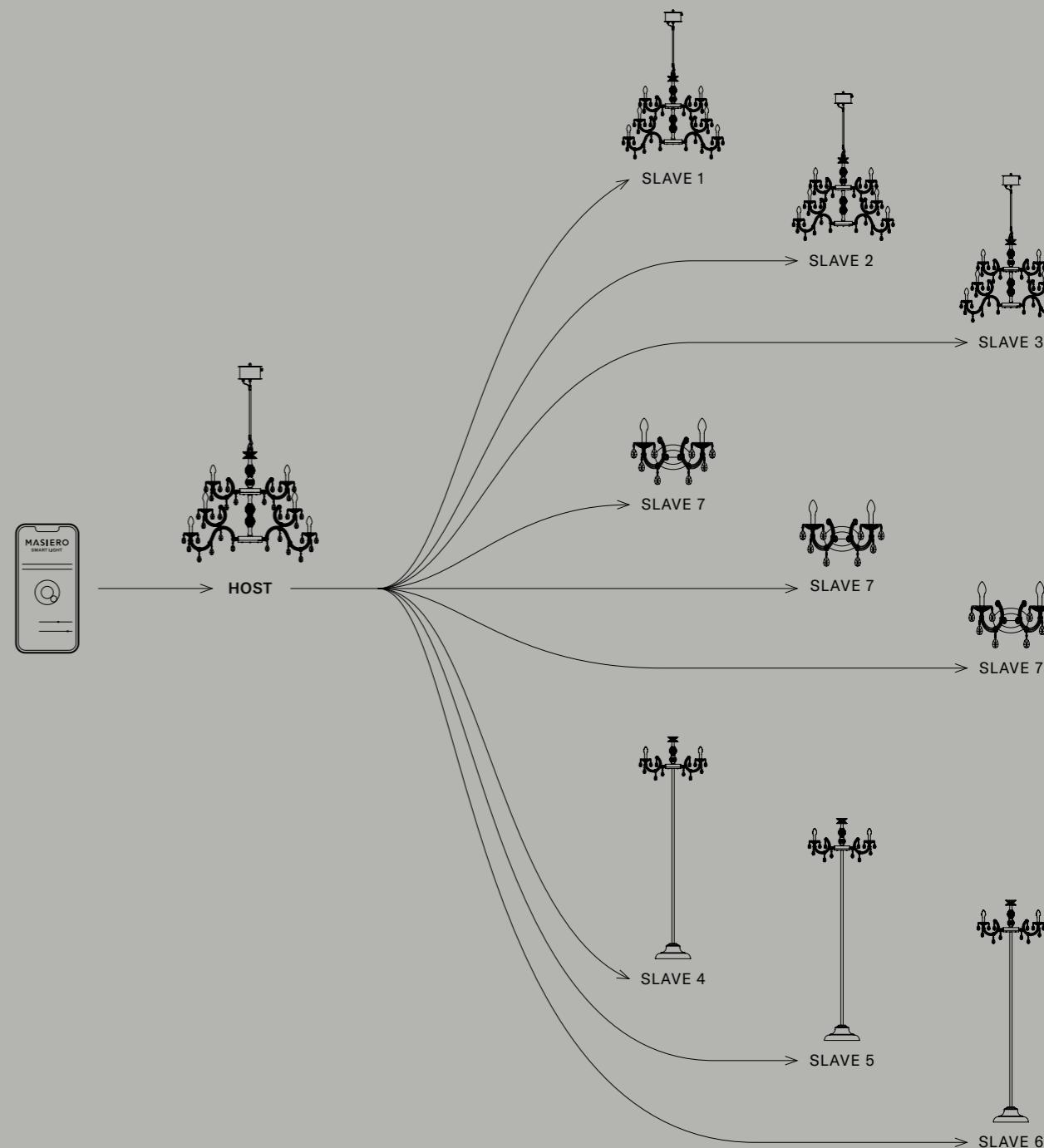

**DRYLIGHT S6 WHITE**  IP66

Ø	75 cm / 29.50"
H	125 cm / 49.20"
W	7,3 kg / 16,09 lb EXTREME 8,7 kg / 19,18 lb PREMIUM
H ROD 45	45 cm / 17.70" STANDARD
H ROD 35	35 cm / 13.80" ON REQUEST
H ROD 25	25 cm / 9.80" ON REQUEST

INTEGRATED LED LIGHTING	
	6xWHITE LED SOURCE – 3000 K 13 W TOT – 1600 NOMINAL LM (DRIVER INCLUDED)
DIMM	NO
USA	6xWHITE LED SOURCE – 3000 K 13 W TOT – 1600 NOMINAL LM (DRIVER INCLUDED)
DIMM	1-10V + PUSH

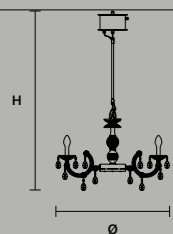

**DRYLIGHT S12 WHITE**  IP66

Ø	113 cm / 44.50"
H	135 cm / 53.10"
W	10,6 kg / 23,36 lb EXTREME 13,4 kg / 29,54 lb PREMIUM
H ROD 45	45 cm / 17.70" STANDARD
H ROD 35	35 cm / 13.80" ON REQUEST
H ROD 25	25 cm / 9.80" ON REQUEST

INTEGRATED LED LIGHTING	
	12xWHITE LED SOURCE – 3000 K 26 W TOT – 3360 NOMINAL LM (DRIVER INCLUDED)
DIMM	TRIAC
USA	12xWHITE LED SOURCE – 3000 K 26 W TOT – 3360 NOMINAL LM (DRIVER INCLUDED)
DIMM	1-10V + PUSH

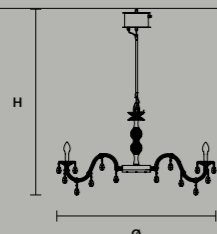

**DRYLIGHT S18 WHITE**  IP66

Ø	113 cm / 44.50"
H	150 cm / 59.10"
W	16,1 kg / 35,49 lb EXTREME 20,2 kg / 44,53 lb PREMIUM
H ROD 45	45 cm / 17.70" STANDARD
H ROD 35	35 cm / 13.80" ON REQUEST
H ROD 25	25 cm / 9.80" ON REQUEST

BOX	
Øb	20 cm / 7.87"
Hb	10 cm / 3.94"
INTEGRATED LED LIGHTING	
	18xWHITE LED SOURCE – 3000 K 39 W TOT – 5040 NOMINAL LM (DRIVER INCLUDED)
DIMM	TRIAC
USA	18xWHITE LED SOURCE – 3000 K 39 W TOT – 5040 NOMINAL LM (DRIVER INCLUDED)
DIMM	1-10V + PUSH

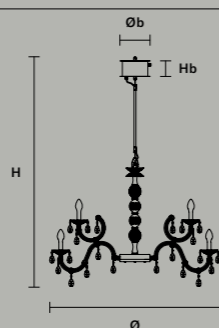

**DRYLIGHT S24 WHITE**  IP66

Ø	113 cm / 44.50"
H	165 cm / 65.00"
W	23,5 kg / 51,80 lb EXTREME 29,7 kg / 65,47 lb PREMIUM
H ROD 45	45 cm / 17.70" STANDARD
H ROD 35	35 cm / 13.80" ON REQUEST
H ROD 25	25 cm / 9.80" ON REQUEST

BOX	
Øb	20 cm / 7.87"
Hb	10 cm / 3.94"
INTEGRATED LED LIGHTING	
	24xWHITE LED SOURCE – 3000 K 52 W TOT – 6720 NOMINAL LM (DRIVER INCLUDED)
DIMM	TRIAC
USA	24xWHITE LED SOURCE – 3000 K 52 W TOT – 6720 NOMINAL LM (DRIVER INCLUDED)
DIMM	1-10V + PUSH

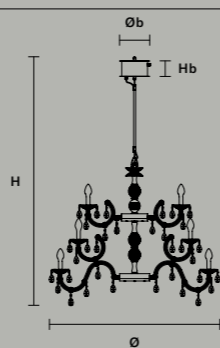

**DRYLIGHT S6 RGB-W**  IP66

Ø	75 cm / 29.50"
H	125 cm / 49.20"
W	7,3 kg / 16,09 lb EXTREME 8,7 kg / 19,18 lb PREMIUM
H ROD 45	45 cm / 17.70" STANDARD
H ROD 35	35 cm / 13.80" ON REQUEST
H ROD 25	25 cm / 9.80" ON REQUEST

INTEGRATED LED LIGHTING	
	6xRGB-W LED SOURCE 24 W TOT (DRIVER INCLUDED) DIMMABLE
USA	6xRGB-W LED SOURCE 24 W TOT (DRIVER INCLUDED) DIMMABLE

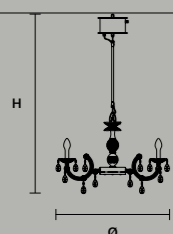

**DRYLIGHT S12 RGB-W**  IP66

Ø	113 cm / 44.50"
H	135 cm / 53.10"
W	10,6 kg / 23,36 lb EXTREME 13,4 kg / 29,54 lb PREMIUM
H ROD 45	45 cm / 17.70" STANDARD
H ROD 35	35 cm / 13.80" ON REQUEST
H ROD 25	25 cm / 9.80" ON REQUEST

INTEGRATED LED LIGHTING	
	12xRGB-W LED SOURCE 48 W TOT (DRIVER INCLUDED) DIMMABLE
USA	12xRGB-W LED SOURCE 48 W TOT (DRIVER INCLUDED) DIMMABLE

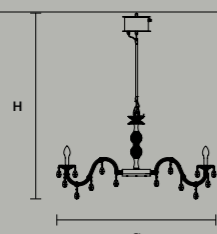

**DRYLIGHT S18 RGB-W**  IP66

Ø	113 cm / 44.50"
H	150 cm / 59.10"
W	16,1 kg / 35,49 lb EXTREME 20,2 kg / 44,53 lb PREMIUM
H ROD 45	45 cm / 17.70" STANDARD
H ROD 35	35 cm / 13.80" ON REQUEST
H ROD 25	25 cm / 9.80" ON REQUEST

BOX	
Øb	20 cm / 7.87"
Hb	14 cm / 5.51"
INTEGRATED LED LIGHTING	
	18xRGB-W LED SOURCE 72 W TOT (DRIVER INCLUDED) DIMMABLE
USA	18xRGB-W LED SOURCE 72 W TOT (DRIVER INCLUDED) DIMMABLE

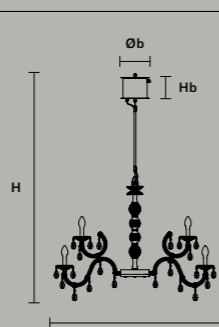

**DRYLIGHT S24 RGB-W**  IP66

Ø	113 cm / 44.50"
H	165 cm / 65.00"
W	23,5 kg / 51,80 lb EXTREME 29,7 kg / 65,47 lb PREMIUM
H ROD 45	45 cm / 17.70" STANDARD
H ROD 35	35 cm / 13.80" ON REQUEST
H ROD 25	25 cm / 9.80" ON REQUEST

BOX	
Øb	20 cm / 7.87"
Hb	14 cm / 5.51"
INTEGRATED LED LIGHTING	
	24xRGB-W LED SOURCE 96 W TOT (DRIVER INCLUDED) DIMMABLE
USA	24xRGB-W LED SOURCE 96 W TOT (DRIVER INCLUDED) DIMMABLE

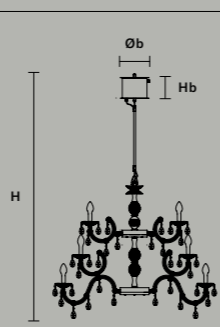

**DRYLIGHT A2 WHITE**  IP66

L	44 cm / 17.30"
SP	30 cm / 11.80"
H	37 cm / 14.60"

INTEGRATED LED LIGHTING	
	2xWHITE LED SOURCE – 3000 K 5 W TOT – 560 NOMINAL LM (DRIVER INCLUDED)
DIMM	NO
USA	2xWHITE LED SOURCE – 3000 K 5 W TOT – 560 NOMINAL LM (DRIVER INCLUDED)
DIMM	NO

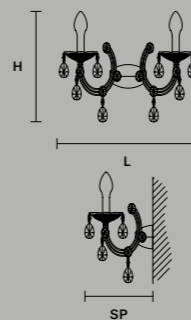

**DRYLIGHT TL6 WHITE**  IP44\*

Ø	75 cm / 29.50"
H	120 cm / 47.20"

INTEGRATED LED LIGHTING	
	6xWHITE LED SOURCE – 3000 K 13 W TOT – 1600 NOMINAL LM (DRIVER INCLUDED)
DIMM	NO
USA	6xWHITE LED SOURCE – 3000 K 13 W TOT – 1600 NOMINAL LM (DRIVER INCLUDED)
DIMM	1-10 + PUSH
BATTERY POWER (OPTIONAL) *	
	10 hours AUTONOMY 5 hours TO RECHARGE

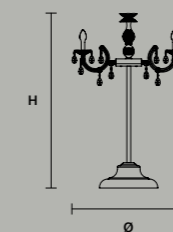

**DRYLIGHT TL6 STAKE WHITE**  IP44\*

Ø	75 cm / 29.50"
H	120 cm / 47.20"

INTEGRATED LED LIGHTING	
	6xWHITE LED SOURCE – 3000 K 13 W TOT – 1600 NOMINAL LM (DRIVER INCLUDED)
DIMM	NO
USA	6xWHITE LED SOURCE – 3000 K 13 W TOT – 1600 NOMINAL LM (DRIVER INCLUDED)
DIMM	1-10 + PUSH
BATTERY POWER (OPTIONAL) *	
	10 hours AUTONOMY 5 hours TO RECHARGE

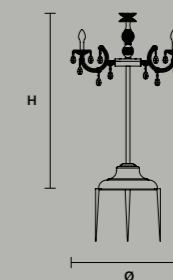

**DRYLIGHT A2 RGB-W**  IP66

L	44 cm / 17.30"
SP	30 cm / 11.80"
H	37 cm / 14.60"

FLUSH-MOUNTED BOX (NOT INCLUDED)	
Lb	10 cm / 3.93"
SPb	7 cm / 2.75"
H	10 cm / 3.93"
INTEGRATED LED LIGHTING	
	2xRGB-W LED SOURCE 8 W TOT (DRIVER INCLUDED) DIMMABLE
USA	2xRGB-W LED SOURCE 8 W TOT (DRIVER INCLUDED) DIMMABLE

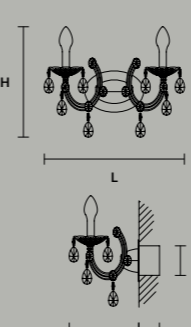

**DRYLIGHT TL6 RGB-W**  IP44\*

Ø	75 cm / 29.50"
H	120 cm / 47.20"

INTEGRATED LED LIGHTING	
	6xRGB-W LED SOURCE 24 W TOT (DRIVER INCLUDED) DIMMABLE
USA	6xRGB-W LED SOURCE 24 W TOT (DRIVER INCLUDED) DIMMABLE
BATTERY POWER (OPTIONAL) *	
	10 hours AUTONOMY 5 hours TO RECHARGE

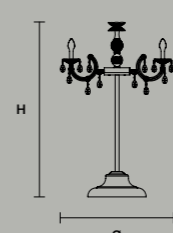

**DRYLIGHT TL6 STAKE RGB-W**  IP44\*

Ø	75 cm / 29.50"
H	120 cm / 47.20"

INTEGRATED LED LIGHTING	
	6xRGB-W LED SOURCE 24 W TOT (DRIVER INCLUDED) DIMMABLE
USA	6xRGB-W LED SOURCE 24 W TOT (DRIVER INCLUDED) DIMMABLE
BATTERY POWER (OPTIONAL) *	
	10 hours AUTONOMY 5 hours TO RECHARGE

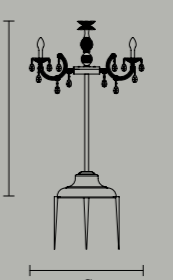

**DRYLIGHT STL6 WHITE** 

Ø 75 cm / 29.50"  
H 245 cm / 96.50"

<b>INTEGRATED LED LIGHTING</b>	
6xWHITE LED SOURCE – 3000 K 13 W TOT – 1600 NOMINAL LM (DRIVER INCLUDED)	
DIMM	NO
USA	6xWHITE LED SOURCE – 3000 K 13 W TOT – 1600 NOMINAL LM (DRIVER INCLUDED)
DIMM	1-10V + PUSH
<b>BATTERY POWER (OPTIONAL) *</b>	
10 hours AUTONOMY 5 hours TO RECHARGE	

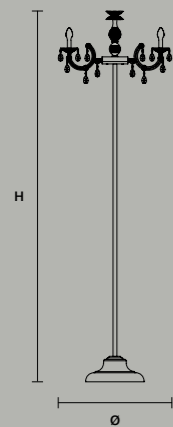

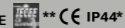
**DRYLIGHT STL6 STAKE WHITE** 

Ø 75 cm / 29.50"  
H 245 cm / 96.50"

<b>INTEGRATED LED LIGHTING</b>	
6xWHITE LED SOURCE – 3000 K 13 W TOT – 1600 NOMINAL LM (DRIVER INCLUDED)	
DIMM	NO
USA	6xWHITE LED SOURCE – 3000 K 13 W TOT – 1600 NOMINAL LM (DRIVER INCLUDED)
DIMM	1-10V + PUSH
<b>BATTERY POWER (OPTIONAL) *</b>	
10 hours AUTONOMY 5 hours TO RECHARGE	



**DRYLIGHT STL6 RGB-W** 

Ø 75 cm / 29.50"  
H 245 cm / 96.50"

<b>INTEGRATED LED LIGHTING</b>	
6xRGB-W LED SOURCE 24 W TOT (DRIVER INCLUDED) DIMMABLE	
USA	6xRGB-W LED SOURCE 24 W TOT (DRIVER INCLUDED) DIMMABLE
<b>BATTERY POWER (OPTIONAL) *</b>	
10 hours AUTONOMY 5 hours TO RECHARGE	



**DRYLIGHT STL6 STAKE RGB-W** 

Ø 75 cm / 29.50"  
H 245 cm / 96.50"

<b>INTEGRATED LED LIGHTING</b>	
6xRGB-W LED SOURCE 24 W TOT (DRIVER INCLUDED) DIMMABLE	
USA	6xRGB-W LED SOURCE 24 W TOT (DRIVER INCLUDED) DIMMABLE
<b>BATTERY POWER (OPTIONAL) *</b>	
10 hours AUTONOMY 5 hours TO RECHARGE	



**\*IP66 FOR BATTERY VERSION**  
**\*\* NOT AVAILABLE FOR BATTERY VERSION**

**DRYLIGHT HANGING ROD**

H ROD 45 45 cm / 17.70"  
H ROD 35 35 cm / 13.80"  
H ROD 25 25 cm / 9.80"

**HANGING ROD**  
1 x 17.70" rod already assembled in the standard suspension. Maximum extension: 90 cm - 35.40" in addition to the standard.

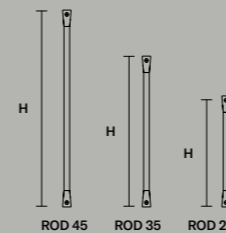

**DRYLIGHT SUPPORT**

L 230–272 cm / 90.60"–107.10"  
H 335–260 cm / 131.90"–102.40"

**MATERIALS**  
Zin-coated and painted metal structure with adjustable height. Base geared for fixing to the ground, 51.20" x 51.20" with cross brackets for square concrete slabs.

We suggest to fix 4 square slabs 23.60" x 23.60", 33 Kg each. (Not included)

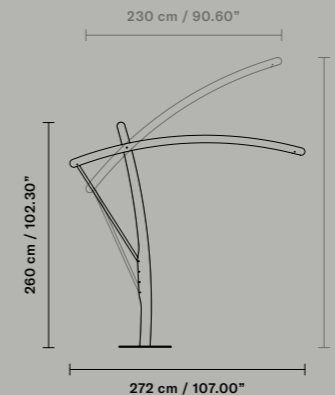

# Technical info



# Finishings

VERNICIATURA RAGGRINZATA OPACA  
FINE TEXTURE PAINT

---



E50 Windy Blue

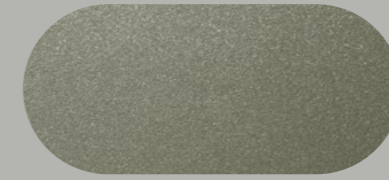

E60 Highland



E70 Champagne



E71 Silver Chrome



E80 Canyon



E81 Hazelnut



E95 Pure White



E98 Deep Black



E99 Desert Gold

## General informations

<b>CE</b>	<b>ETL</b> <sup>us</sup>
-----------	--------------------------

Attesta la conformità del prodotto alle disposizioni delle Direttive comunitarie.

It certifies the conformity of the products to the European Community provisions.

Konformität des Produktes mit den Richtlinien der europäischen Gemeinschaft.

Certifica la conformidad del producto según las disposiciones de las directivas comunitarias.

Il atteste la conformité du produit aux dispositions des directives communitaires.

НАСТОЯЩИМ ПОДТВЕРЖДАЕТСЯ СООТВЕТСТВИЕ ПРОДУКЦИИ ПОЛОЖЕНИЯМ ДИРЕКТИВ ЕС.

CE 标记是指产品的制造商证明该产品符合适用的EC指令的所有基本要求.

يُشَهِد بمطابقة المنتج لأحكام توجيهات الاتحاد الأوروبي.

Il logo “ETL” si riferisce agli articoli che possono essere modificati con componenti certificati ETL. L'elenco degli articoli ETL si riferisce a prodotti testati e valutati in base agli standard di sicurezza del mercato statunitense. Per il mercato USA fare riferimento al listino dedicato.

“ETL” logos refers to articles which can be modified with ETL-compliance components. The “ETL” listing articles stands for tested and evaluated product to recognised US safety standards. For the US market, refer to the relevant price list.

Das "ETL"-Logo bezieht sich auf Artikel, die mit ETL-zertifizierten Komponenten modifiziert werden können. Die Liste der ETL-Artikel bezieht sich auf Produkte, die nach den Sicherheitsstandards des US-Marktes getestet und bewertet wurden. Für den US-Markt beachten Sie bitte die entsprechende Preisliste.

El logo “ETL” indica los artículos, que pueden modificarse con componentes certificados ETL. La lista de los artículos ETL se refiere a los productos sometidos a prueba y evaluados en función de los estándares de seguridad del mercado estadounidense. Consultar la lista de precios específica para el mercado de los Estados Unidos.

“ETL” logo se réfère aux articles qui peuvent être modifiées par des composants certifiés ETL. la liste des articles ETL se réfère à des produits testés et évalués selon les normes de sécurité du marché américain. Pour le marché américain se référer à la liste des prix.

логотип «ETL» относится к элементам, которые могут быть модифицированы спомощью сертифицированных ETL компонентов. список элементов eTL относится к продукции, протестированной и оцененной в соответствии с признанными стандартами безопасности США. для потребителей Находящихся в США см. соответствующий прайс-лист.

“ETL” 徽标是指可以使用ETL认证的组件进行修改的项目。ETL项目列表是指根据美国市场的安全标准进行测试和评估的产品。 对于美国市场，请参考美国市场价格表。

يشير شعار "ETL" إلى المنتجات التي يمكن تعديلها باستخدام مكونات مُعتمدة من ETL. تشير قائمة منتجات ETL إلى المنتجات التي تم اختبارها وتقييمها وفقًا لمعايير السلامة في السوق الأمريكي. بالنسبة لسوق الولايات المتحدة الأمريكية، يُرجى الرجوع إلى قائمة الأسعار المُخصصة.

### Im

Flusso luminoso nominale. L'indicazione si riferisce al valore in assenza di rifrazione, come dichiarato dal produttore del componente.

Nominal luminous flux. It refers to the value without any refraction, as declared by the component manufacturer.

Die Masseinheit für den Lichtstrom. Die Angabe bezieht sich auf den Wert in der Abwesenheit von Brechung, wie vom Hersteller der Komponente angegeben.

Flujo luminoso nominal. La indicación se refiere al valor sin refracción, como declarado por el fabricante del componente.

L'unité SI de flux lumineux. L'indication corresponds à la valeur en l'absence de réfraction, comme indiqué par le fabricant du composant.

НОМИНАЛЬНЫЙ СВЕТОВОЙ ПОТОК. УКАЗАНИЕ ОТНОСИТСЯ К ЗНАЧЕНИЮ В ОТСУТСТВИЕ РЕФРАКЦИИ, КАК ЗАЯВЛЕНО ПРОИЗВОДИТЕЛЕМ КОМПОНЕНТОВ.

标称光通量。指示是指组件制造商声明的没有折射的值。

التدفق الضوئي الاسمي.يشير المؤشر إلى القيمة في حالة عدم وجود انكسار للضوء، كما هو مُعلن من قبل الشركة المصنعة للعنصر.



Lo schema IECEE CB è un sistema internazionale per l'accettazione reciproca di rapporti di prova e certificati relativi alla sicurezza di componenti, apparecchiature e prodotti elettrici ed elettronici operative e dei prodotti sulla base di un accordo multilaterale tra i paesi partecipanti e gli organismi di certificazione.

IECEE CB is an international system for the mutual acceptance of test reports and certificates of the safety of components, operational electrical and electronic equipment and products on the basis of a multilateral agreement between participating countries and certification bodies.

Das IECEE CB Schema ist ein internationales System zur gegenseitigen Anerkennung von Testberichten und Zertifikaten bezüglich der Sicherheit von Komponenten, betriebsbereite elektrische und elektronische Geräte und Produkte auf der Grundlage eines multilateralen Abkommens zwischen teilnehmenden Ländern und Zertifizierungsstellen.

IECEE CB es un sistema internacional para la aceptación mutua de informes de ensayo y certificados de seguridad de componentes, equipos y productos eléctricos y electrónicos operativos y de productos, sobre la base de un acuerdo multilateral entre los países participantes y los organismos de certificación.

Le système IECEE CB est un système international d'acceptation mutuelle des rapports d'essai et des certificats de sécurité des composants, équipements et produits électriques et électroniques opérationnels et des produits, sur la base d'un accord multilatéral entre les pays participants et les organismes de certification.

СХЕМА ІЕСЕЕ СВ ПРЕДСТАВЛЯЕТ СОБОЙ МЕЖДУНАРОДНУЮ СИСТЕМУ ВЗАИМНОГО ПРИЗНАНИЯ СЕРТИФИКАТОВ И ОТЧЕТОВ ОБ ИСПЫТАНИЯХ, КАСАЮЩИХСЯ БЕЗОПАСНОСТИ ЭЛЕКТРИЧЕСКИХ И ЭЛЕКТРОННЫХ КОМПОНЕНТОВ И ОБОРУДОВАНИЯ, ОСНОВАННУЮ НА МНОГОСТОРОННЕМ СОГЛАШЕНИИ МЕЖДУ СТРАНАМИ-УЧАСТНИЦАМИ И ОРГАНАМИ ПО СЕРТИФИКАЦИИ.

认证是电工产品测试证书互认体系（CB 体系） 是国际电工委员会电工产品合格测试与认证组织。

مخطط IECEE CB هو نظام دولي للقبول المتبادل لتقارير الاختبار والاعتمادات المتعلقة بسلامة المكونات، والمعدات، والمنتجات الكهربائية والإلكترونية التشغيلية والمنتجات بناءً على اتفاقية متعددة الأطراف بين الدول المشاركة وهيئات الاعتماد.

### IP

Il grado di protezione IP è un parametro definito dallo standard internazionale IEC 60529 utilizzato per valutare il grado di protezione o l'efficacia di tenuta degli involucri elettrici contro l'intrusione di oggetti, acqua, polvere o contatti accidentali. Il grado IP è definito assieme a due valori numerici, il primo riguarda il grado di protezione alla polvere, mentre la seconda si riferisce al grado di impermeabilità all'acqua.

The Ingress Protection (IP) rating is a parameter defined by the international standard IEC 60529 that is used to rate the degree of protection or sealing effectiveness of electrical enclosures against the intrusion of objects, water, dust or accidental contact. The IP rating is defined using two digits, the first digit relates to the degree of protection against dust, while the second digit relates to the degree of impermeability to water.

L'indice IP est un paramètre défini par la norme internationale IEC 60529 utilisé pour évaluer le niveau de protection ou l'efficacité de l'étanchéité des boîtiers électriques contre l'intrusion d'objets, d'eau, de poussière ou les contacts accidentels. L'indice IP est défini par deux valeurs numériques, la première se rapportant au niveau de protection contre la poussière et la seconde au niveau d'imperméabilité à l'eau.

Die IP-Schutzart ist ein von der internationalen IEC-Norm 60529 festgelegter Parameter, der verwendet wird, um den Schutz oder die Wirksamkeit der Dichtheit von elektrischen Gehäusen gegen das Eindringen von Gegenständen, Wasser, Staub oder gegen unbeabsichtigtes Berühren anzugeben. Die IP-Schutzart wird mit zwei Kennziffern definiert, wobei sich die erste Kennziffer auf den Schutz gegen Staub und die zweite Kennziffer auf den Schutz gegen das Eindringen von Wasser bezieht.

El grado de protección IP es un parámetro definido por la norma internacional CEI 60529 que se utiliza para evaluar el grado de protección o la eficacia del aislamiento de las envolturas eléctricas contra la penetración de cuerpos sólidos, agua, polvo o contactos accidentales. El grado de protección IP se define con dos cifras numéricas, la primera se refiere al grado de protección contra el polvo, mientras que la segunda se refiere al grado de protección contra la penetración de agua.

СТЕПЕНЬ ЗАЩИТЫ ІР - ЭТО ПАРАМЕТР, ОПРЕДЕЛЯЕМЫЙ МЕЖДУНАРОДНЫМ СТАНДАРТОМ ІЕС 60529 И ИСПОЛЬЗУЕМЫЙ ДЛЯ ОЦЕНКИ СТЕПЕНИ ИЛИ ЭФФЕКТИВНОСТИ ЗАЩИТЫ ЭЛЕКТРИЧЕСКИХ ШКАФОВ ОТ ПРОНИКНОВЕНИЯ ПРЕДМЕТОВ, ВОДЫ, ПЫЛИ ИЛИ ОТ СЛУЧАЙНОГО КОНТАКТА. СТЕПЕНЬ ЗАЩИТЫ ІР ОПРЕДЕЛЯЕТСЯ ДВУМЯ ЧИСЛОВЫМИ ЗНАЧЕНИЯМИ, ПЕРВОЕ ОТНОСИТСЯ К СТЕПЕНИ ЗАЩИТЫ ОТ ПЫЛИ, А ВТОРОЕ - К СТЕПЕНИ ВОДОНЕПРОНИЦАЕМОСТИ.

IP防护等级是一个由国际标准IEC 60529定义的参数,用于评估电气外壳针对异物侵入、液体渗入、灰尘进入或意外接触的防护等级或密封效果。

IP等级由两个数值共同定义,第一个表示防尘等级,第二个表示防水等级。

**IP** درجة الحماية **IP** هي معلمة محددة بواسطة المعيار الدولي **IEC 60529** مستخدمة لتقييم درجة الحماية أو فعالية إكحام الحاويات الكهربائية ضد اقتحام الأشياء، أو الماء، أو الأتربة، أو التلامس العرضي. يتم تحديد درجة الحماية **IP** بقيمتين رقميتين، الأولى تتعلق بدرجة الحماية من الأتربة، بينما تشير الثانية إلى درجة عدم نفاذية الماء.

## MASIERO

Masiero si riserva il diritto di apportare ai propri articoli, senza nessun preavviso, qualsiasi modifica ritenesse opportuna.

Masiero reserves the right to introduce any changes to its own products, without notice in advance.

Masiero behalt sich das Recht vor nderungen vorzunehmen, ohne sofortige Benachrichtigung.

Masiero se reserva el derecho de aportar modificaciones consideradas oportunas a sus artculos sin preaviso.

Masiero se rserve le droit d'apporter une quelconque modification  les modles sans pravis.

КОМПАНИЯ MASIERO ОСТАВЛЯЕТ ЗА СОБОЙ ПРАВО БЕЗ ПРЕДВАРИТЕЛЬНОГО УВЕДОМЛЕНИЯ, ЕСЛИ ЭТО БУДЕТ СОЧТЕНО ЦЕЛЕСООБРАЗНЫМ, ВНОСИТЬ В СОБСТВЕННЫЕ МОДЕЛИ ЛЮБЫЕ ИЗМЕНЕНИЯ.

Masiero保留对其认为适当的任何更改的权利，恕不另行通知。

تحتفظ شركة مازيرو "Masiero" بالحق في إجراء أي تعديلات تراها مناسبة على منتجاتها، دون إشعار مسبق.



ART DIRECTION, DESIGN  
Designwork

LAYOUT  
Masiero

PRINT  
Italy, March 2023  
by Grafica Antiga

Masiero srl

via Peschiere, 53  
31032 Casale sul Sile  
Treviso, Italy  
T +39 0422 7861  
F +39 0422 786250

info@masierogroup.com  
masierogroup.com

Masiero USA LTD

100 Park Avenue  
Suite 1600  
New York, NY 10017  
T +1 212 4666754

sales@masiero-usa.com  
masiero-usa.com



